



1955-57 Chevrolet Full-Size

with V8 Position
Condenser Kit *with* Drier
(025709)



18865 Goll St. San Antonio, TX 78266
Phone: 800-862-6658
Sales: sales@vintageair.com
Tech Support: tech@vintageair.com
www.vintageair.com



www.vintageair.com

Table of Contents

Cover.....	1
Table of Contents.....	2
Packing List/Parts Disclaimer.....	3
Important Notice.....	4
Core Support Measurements.....	5
Engine Compartment Disassembly.....	6
Core Support Modification, Condenser Mounting Bracket Installation.....	7
Condenser Mounting Bracket Installation (Cont.).....	8
Drier & Drier Bracket Installation, Hardline & Binary Switch Installation.....	9
Hardline & Binary Switch Installation (Cont.).....	10
Lubricating O-rings, Final Steps.....	11
Packing List.....	12



www.vintageair.com

Packing List: Condenser Kit (025709)

No.	Qty.	Part No.	Description
1.	1	037036	Condenser, 17" x 19", Parallel Flow
2.	1	07321-VUC	Drier
3.	1	23135-VUW	Compressor Lead
4.	1	11079-VUS	Binary Switch, Male
5.	1	646906	Bracket, Drier
6.	1	646908	Bracket, Core Support Template
7.	1	647192	Bracket, Condenser, Passenger Side
8.	1	647194	Bracket, Condenser, Driver Side
9.	1	091614	Hardline, #6 Condenser/Drier
10.	1	091615	Hardline, #8 Condenser/Compressor
11.	1	18125-VUB	Washer, 1/4", Flat
12.	1	18152-VUB	Nut with Star Washer, 1/4-20
13.	8	18249-VUB	Screw, 10-24 x 3/8"
14.	8	18260-VUB	Nut with Star Washer, 10-24
15.	2	33134-VUI	Grommet, 2-Hole
16.	2	33857-VUF	O-ring, #6
17.	1	33858-VUF	O-ring, #8
18.	1	41117-VUP	Refrigerant Oil

**** Before beginning installation, open all packages and check contents of shipment. Please report any shortages directly to Vintage Air within 15 days. After 15 days, Vintage Air will not be responsible for missing or damaged items.**

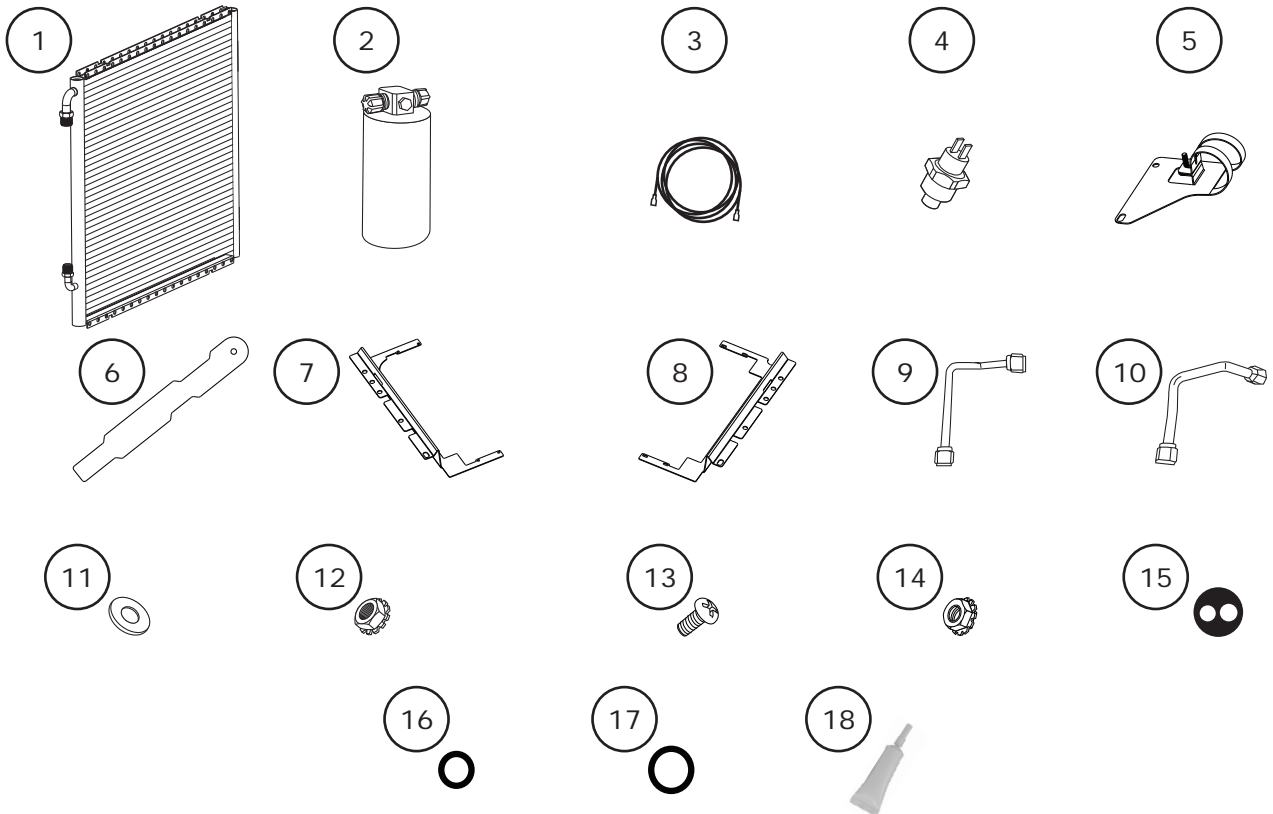

NOTE: Images may not depict actual parts and quantities. Refer to packing list for actual parts and quantities.



www.vintageair.com

Important Notice—Please Read

For Maximum System Performance, Vintage Air Recommends the Following:

NOTE: Vintage Air systems are designed to operate with R134a refrigerant only. Use of any other refrigerant could damage your A/C system and/or vehicle, and possibly cause a fire, in addition to potentially voiding the warranties of the A/C system and its components.

Refrigerant Capacities:

Vintage Air System: 1.8 lbs. (28.8 oz.) or 816 grams of **R134a**, charged by weight with a quality charging station or scale. **NOTE: Use of the proper type and amount of refrigerant is critical to system operation and performance.**

Other Systems: Consult manufacturer's guidelines.

Lubricant Capacities:

New Vintage Air-Supplied Sanden Compressor: No additional oil needed (Compressor is shipped with proper oil charge).

All Other Compressors: Consult manufacturer (Some compressors are shipped dry and will need oil added).

Safety Switches

Your Vintage Air system is equipped with a binary pressure safety switch. A binary switch disengages the compressor clutch in cases of extreme low pressure conditions (refrigerant loss) or excessively high head pressure (406 PSI) to prevent compressor damage or hose rupture. A trinary switch combines Hi/Lo pressure protection with an electric fan operation signal at 254 PSI, and should be substituted for use with electric fans. Compressor safety switches are extremely important since an A/C system relies on refrigerant to circulate lubricant.

Service Info:

Protect Your Investment: Prior to assembly, it is critical that the compressor, evaporator, A/C hoses and fittings, hardlines, condenser and receiver/drier remain capped. Removing caps prior to assembly will allow moisture, insects and debris into the components, possibly leading to reduced performance and/or premature failure of your A/C system. This is especially important with the receiver/drier.

Additionally, when caps are removed for assembly, **BE CAREFUL!** Some components are shipped under pressure with dry nitrogen.

Evacuate the System for 35-45 Minutes: Ensure that system components (Drier, compressor, evaporator and condenser) are at a temperature of at least 85°F. On a cool day, the components can be heated with a heat gun **or** by running the engine with the heater on before evacuating. Leak check and charge to specifications.

Bolts Passing Through Cowl and/or Firewall:

To ensure a watertight seal between the passenger compartment and the vehicle exterior, for all bolts passing through the cowl and/or firewall, Vintage Air recommends coating the threads with silicone prior to installation.

Heater Hose (not included with this kit):

Heater hose may be purchased from Vintage Air (Part#31800-VUD) or your local parts retailer. Routing and required length will vary based on installer preference.



www.vintageair.com

Core Support Measurements

This kit was developed based on the measurements below, which were taken from a 1957 Chevrolet Bel Air V8.

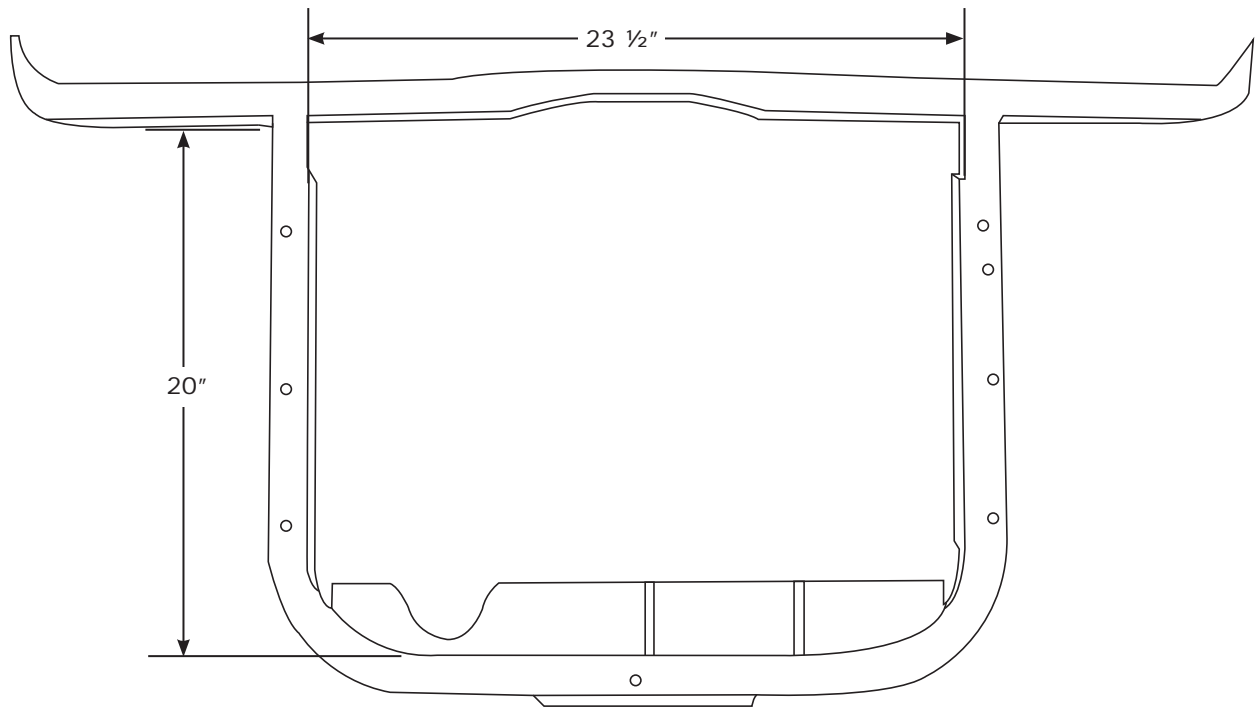



www.vintageair.com

Engine Compartment Disassembly

NOTE: Before starting the installation, check the function of the vehicle (horn, lights, etc.) for proper operation, and study the instructions, illustrations, & diagrams.

Perform the following:

1. Disconnect the battery.
2. Remove the battery (retain).
3. Remove the battery tray by removing (2) bolts from the core support and (2) bolts from under the inner fender (retain) (See Photos 1 & 2, below).
4. Remove the driver-side horn by removing the bolt securing the horn to the core support (retain) (See Photo 3, below).
5. Remove the passenger-side core support panel and horn by removing (4) bolts under the inner fender, (1) bolt under the splash apron, and (5) bolts from the front of the panel (retain) (See Photo 4, below).
6. Remove the radiator by removing (6) bolts, ((3) on each side of the radiator) (See Photo 5, below), as well as the transmission cooling lines (if equipped) (retain).

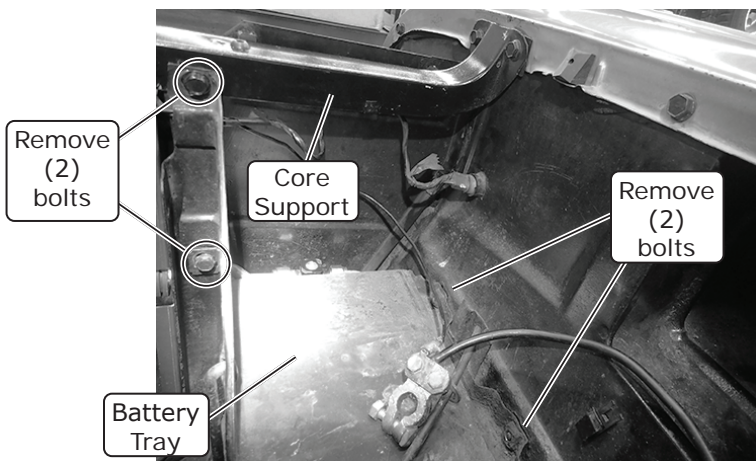

Photo 1

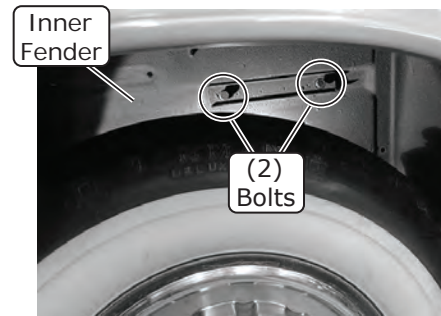

Photo 2

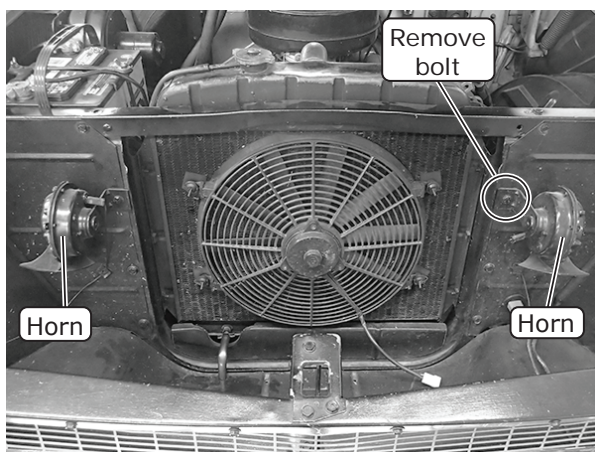

Photo 3

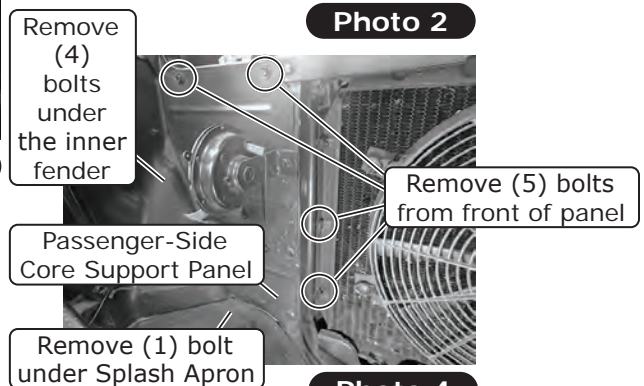

Photo 4

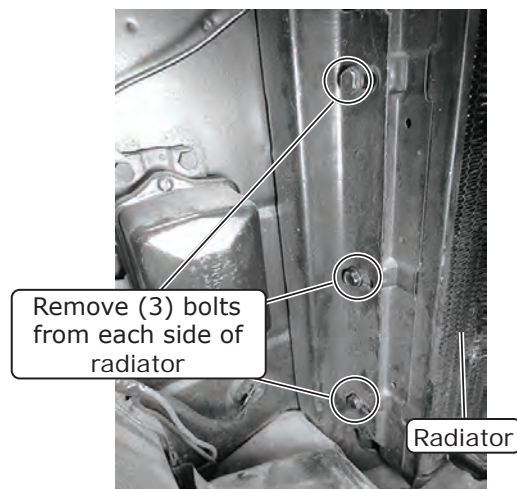

Photo 5



www.vintageair.com

Core Support Modification

1. Insert the core support template bracket into the passenger side inner channel of the core support. Align the template cutouts to clear the core support weld nuts, then clamp the template in place. **NOTE: Make sure the template is firmly against the upper cross brace of the core support.**
2. Mark, then center punch the core support template hole, and drill a 1/4" pilot hole (See Photo 1, below).
3. Remove the template, and enlarge the previously drilled 1/4" hole to 1 1/4" using a step drill or hole saw (See Photo 2, below).
4. Clean and deburr the hole (See Photo 2, below).

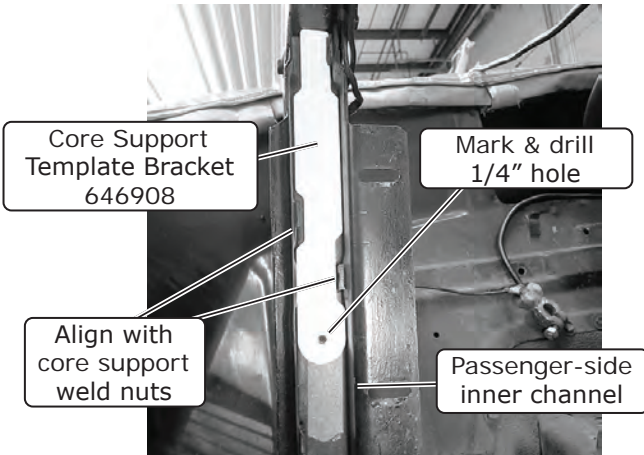

Photo 1

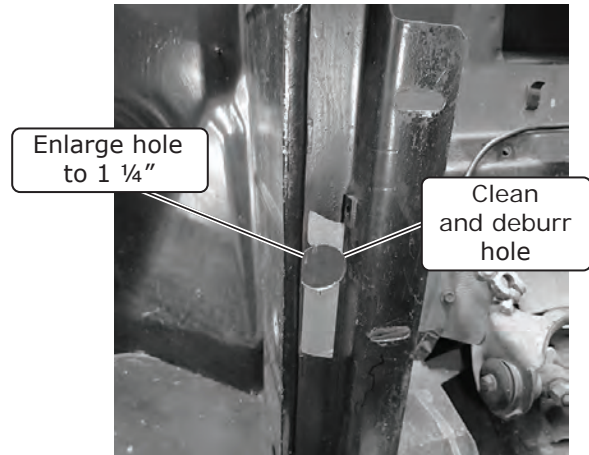

Photo 2

Condenser Mounting Bracket Installation

1. On a workbench, place the condenser front side down, and install the passenger side condenser bracket onto the upper and lower flanges of the condenser using (4) 10-24 x 3/8" screws and (4) 10-24 nuts with star washers as shown in Photo 1, below. **NOTE: The bracket mounts to the 1st & 3rd holes on the condenser flange (See Photo 2, below).**

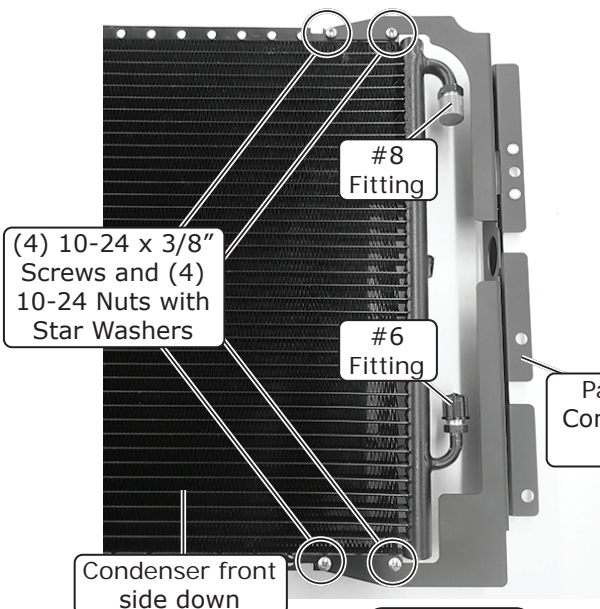

Photo 1

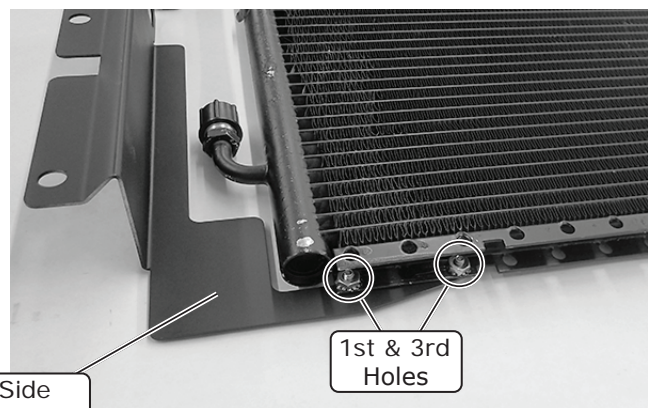

Photo 2



www.vintageair.com

Condenser Mounting Bracket Installation (Cont.)

2. Install the driver-side condenser bracket onto the upper and lower flanges on the condenser using (4) 10-24 x 3/8" screws and (4) 10-24 nuts with star washers as shown in Photo 3, below. **NOTE: The bracket mounts to the 1st & 3rd holes on the condenser flange (See Photo 4, below).**
3. Install the condenser assembly onto the front of the core support using the OEM bolts. Install (3) bolts on the driver side and (1) on the top passenger side (See Photos 5, 6, 7 & 8, below). **NOTE: The upper bolt orientation differs from 1955-56 to 1957 core support. Condenser brackets design fitment intent are for 1955-57 core support interchangeability. The passenger side panel can remain off temporarily for easier access during drier assembly and condenser hardline installation.**

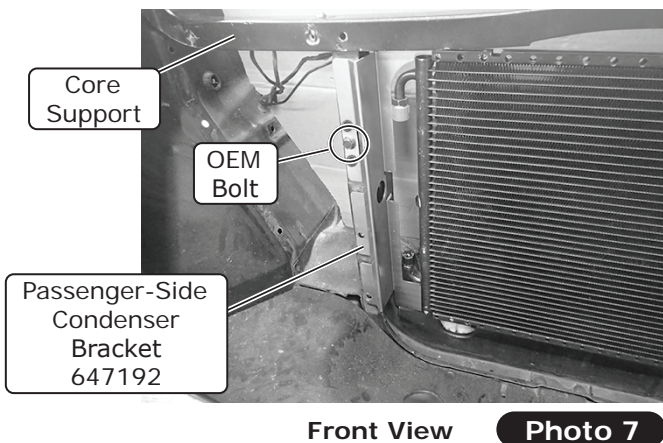
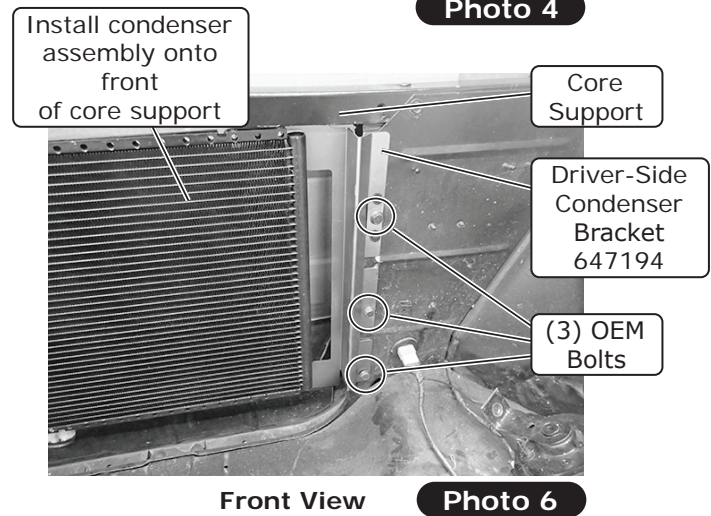
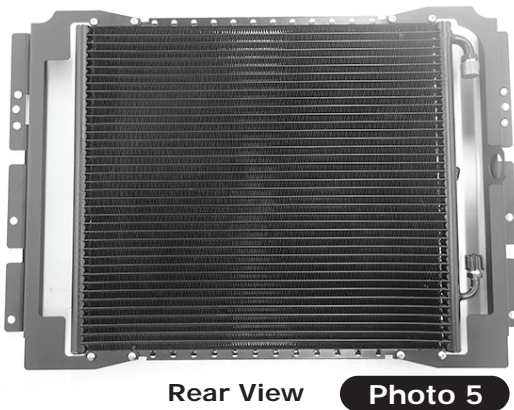
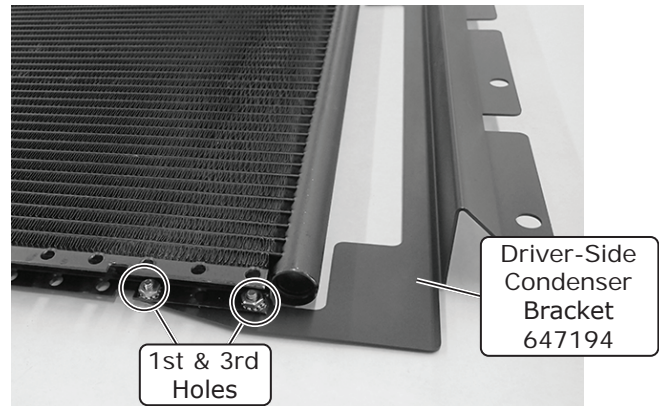
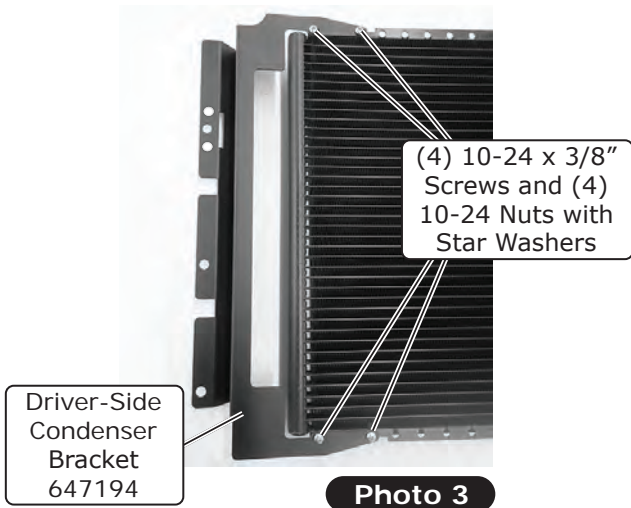



www.vintageair.com

Drier & Drier Bracket Installation

NOTE: Do not remove the caps from the drier until connections are to be made. The drier contains a desiccant that will quickly absorb moisture from the air, causing it to lose effectiveness. For this reason, Vintage Air recommends that the drier remains capped.

Perform the Following:

1. Insert the drier into the drier bracket, and secure it using a 1/4" flat washer and a 1/4-20 nut with star washer (See Photo 1, below). **NOTE: Do not fully tighten the nut at this time.**
2. Install the drier bracket onto the passenger side of the core support using the (2) remaining OEM bolts. The drier assembly will install between the core support and the passenger side condenser bracket (See Photo 2, below). **NOTE: Do not fully tighten the (3) passenger side core support bolts at this time.**
3. Adjust the drier in the clamp so that it does not sit on the bottom of the apron. Leave a gap between the bottom of the drier and the apron (approximately 3/16"), and tighten the nut on the drier clamp just enough to keep the drier in place (See Figure 1, below). **NOTE: Do not fully tighten the drier nut at this time. Final adjustment of the drier is done after the #6 condenser/drier hardline is installed.**

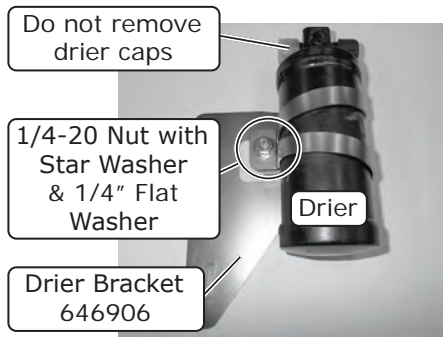

Photo 1

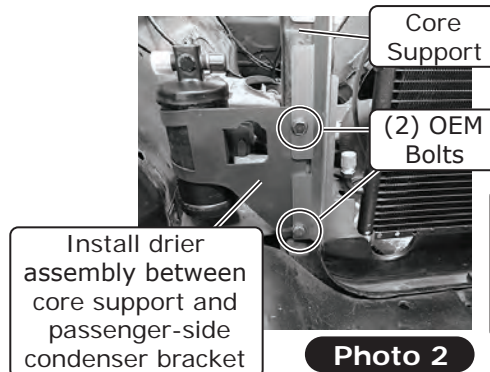

Photo 2

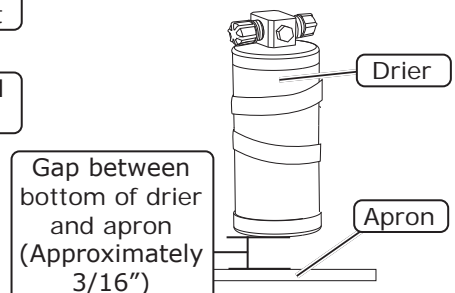

Figure 1

Hardline & Binary Switch Installation

1. Locate the #8 condenser/compressor hardline, and route the hardline through the 1 1/4" passenger side condenser bracket and core support holes as shown in Photo 1, below. The female fitting on the hardline will connect to the #8 fitting on the condenser, and the male end will connect to the #8 condenser/compressor A/C hose. **NOTE: Do not connect the hardline to the condenser at this time.**
2. Locate the #6 condenser/drier hardline, and route the long end of the hardline through the 1 1/4" passenger side condenser bracket and core support holes as shown in Photo 1, below.
3. Using a properly lubricated #6 O-ring, connect the female fitting on the short end of the #6 condenser/drier hardline to the #6 fitting on the condenser (See Photo 2, below, and Figure 2, Page 11). **NOTE: Do not fully tighten the fitting at this time.**

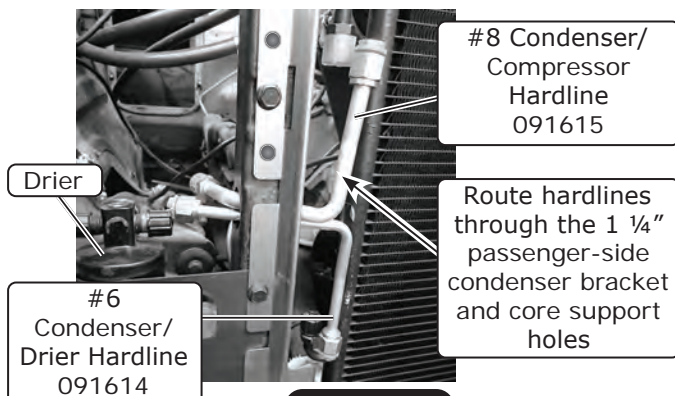

Photo 1

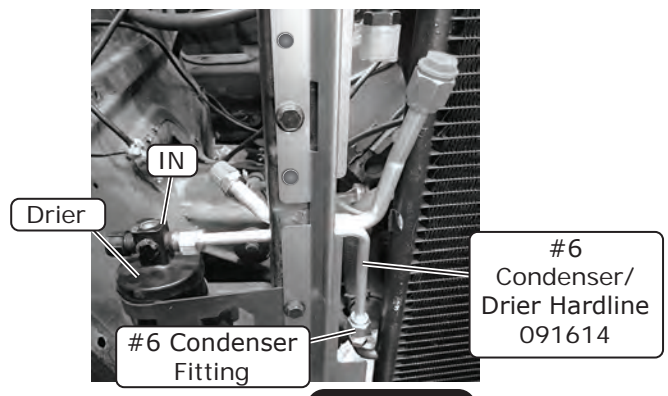

Photo 2



www.vintageair.com

Hardline & Binary Switch Installation (Cont.)

- Using a properly lubricated #6 O-ring, connect the female fitting on the long end of the #6 condenser/drier hardline to the IN fitting on the drier (See Photo 4, below, and Figure 2, Page 11). Raise, lower, or clock the drier as needed to attain a suitable fit (See Photo 3, below), and tighten the nut on the drier clamp. Tighten both ends of the #6 condenser/drier hardline at this time (See Figure 2, Page 11). **NOTE: Refrigerant flow through the drier is IN from condenser, OUT to evaporator.**
- Using a properly lubricated #8 O-ring, connect the female fitting on the #8 condenser/compressor hardline to the #8 fitting on the condenser (See Photo 3, below, and Figure 2, Page 11). Center the hardline in the 1 1/4" core support hole, and tighten the fitting as shown in Figure 2, Page 11.
- Install the male binary switch onto the drier using a properly lubricated O-ring (See Photo 4, below). **NOTE: The binary switch and the drier each come with an O-ring for the binary switch. Only (1) O-ring will be used.**
- Locate (2) 2-hole grommets. Install (1) grommet into the passenger-side condenser bracket hole and (1) into the previously drilled 1 1/4" core support hole (See Photos 5 & 6, below).

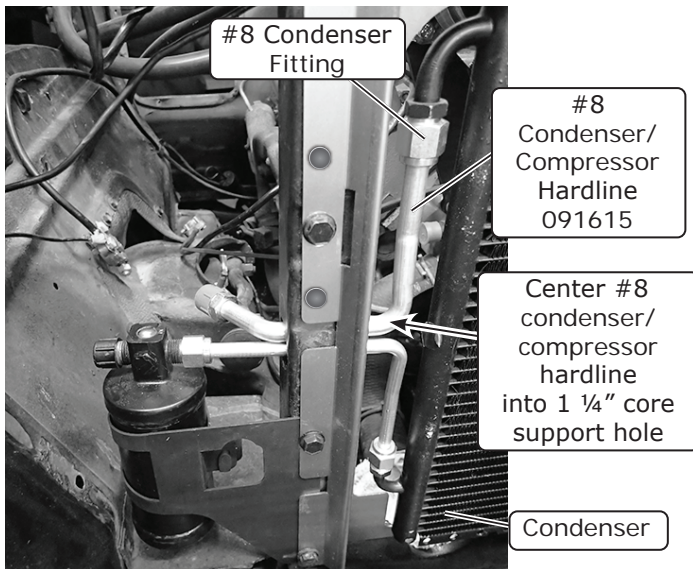

Photo 3

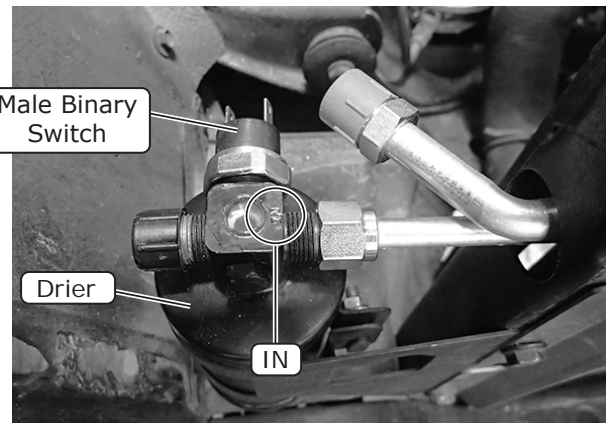

Photo 4

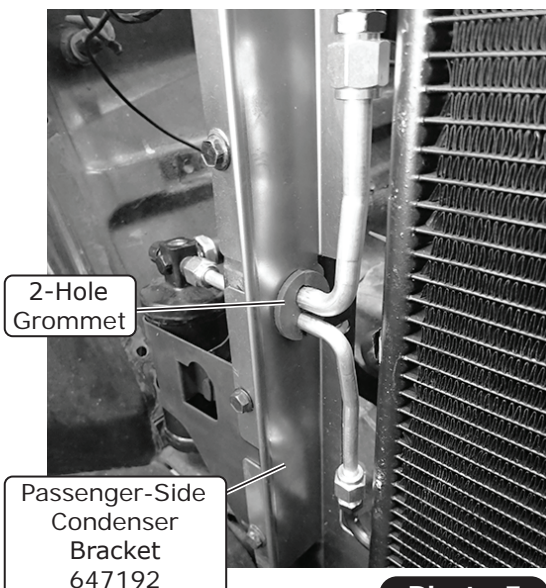

Photo 5

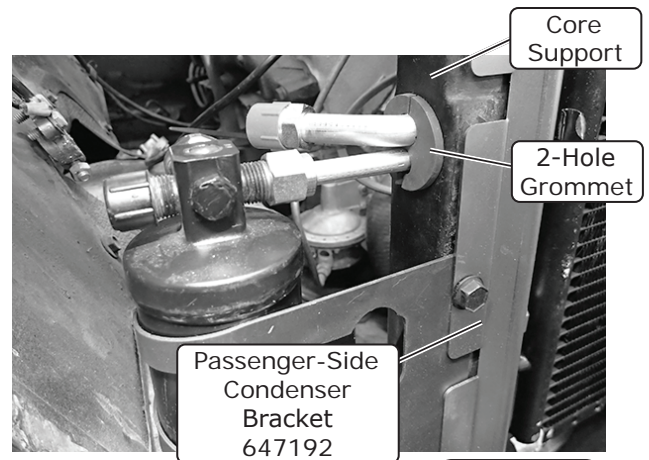
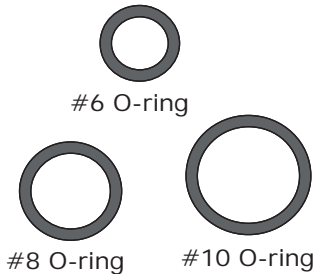

Photo 6



www.vintageair.com

Lubricating O-rings



#6 O-ring

#8 O-ring

#10 O-ring

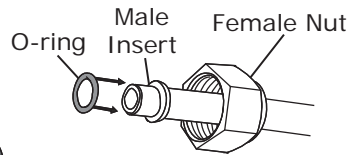

Refrigerant Oil for O-rings

O-ring installs over male insert to swaged lip

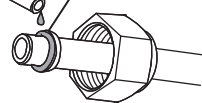

For a proper seal of fittings: Install supplied O-rings as shown and lubricate with refrigerant oil.

Figure 2

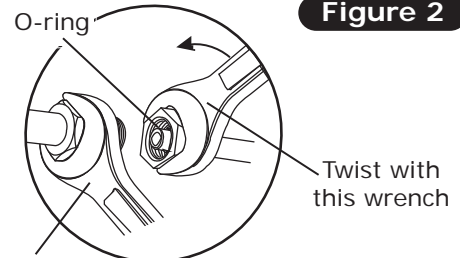

Hold with this wrench

Twist with this wrench

NOTE: Standard torque specifications:

#6: 11 to 13 ft-lb.

#8: 15 to 20 ft-lb.

#10: 21 to 27 ft-lb.

Final Steps

1. Reinstall the passenger-side core support panel. Remove the (3) bolts from the passenger-side condenser and drier brackets. Pull forward slightly on the passenger-side condenser bracket, and insert the panel directly behind the condenser bracket and in front of the drier bracket. Align the bolt holes and reinstall all of the OEM bolts (See Photo 1, below).
2. Reinstall the battery tray using the OEM bolts.
3. Reinstall the radiator. Slide the radiator down from the top behind the core support, and secure it using the OEM bolts. **NOTE: When lowering the radiator into place, make sure the drain plug does not gouge the back of the condenser (See Photo 2, below).**
4. Reinstall the passenger- and driver-side horns in their original locations using the OEM bolts (See Photo 3, below).
5. Reinstall and/or reconnect all remaining items removed or disconnected in the Engine Compartment Disassembly instructions on Page 6. This concludes the condenser kit portion of your installation.

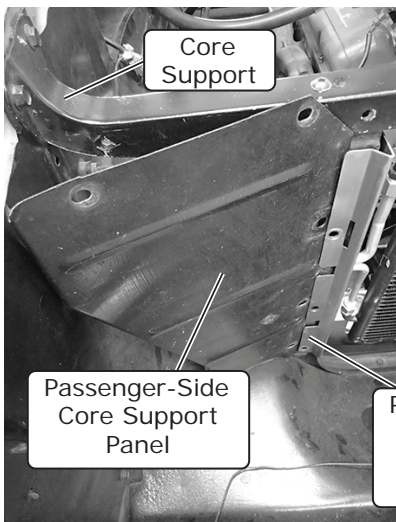

Core Support

Passenger-Side Core Support Panel

Passenger-Side Condenser Bracket 647192

Photo 1

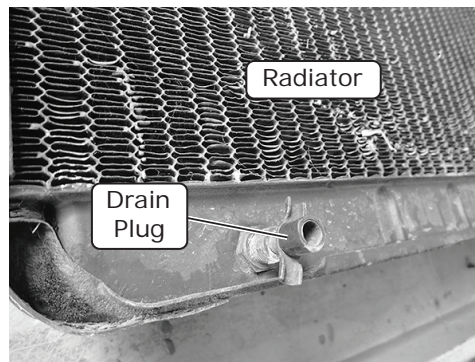

Radiator

Drain Plug

Photo 2

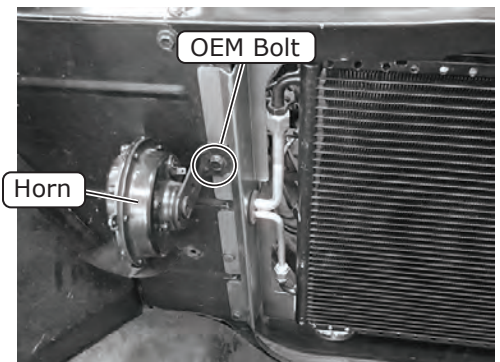

OEM Bolt

Horn

Photo 3



www.vintageair.com

Packing List: Condenser Kit (025709)

No.	Qty.	Part No.	Description
1.	1	037036	Condenser, 17" x 19", Parallel Flow
2.	1	07321-VUC	Drier
3.	1	23135-VUW	Compressor Lead
4.	1	11079-VUS	Binary Switch, Male
5.	1	646906	Bracket, Drier
6.	1	646908	Bracket, Core Support Template
7.	1	647192	Bracket, Condenser, Passenger Side
8.	1	647194	Bracket, Condenser, Driver Side
9.	1	091614	Hardline, #6 Condenser/Drier
10.	1	091615	Hardline, #8 Condenser/Compressor
11.	1	18125-VUB	Washer, 1/4", Flat
12.	1	18152-VUB	Nut with Star Washer, 1/4-20
13.	8	18249-VUB	Screw, 10-24 x 3/8"
14.	8	18260-VUB	Nut with Star Washer, 10-24
15.	2	33134-VUI	Grommet, 2-Hole
16.	2	33857-VUF	O-ring, #6
17.	1	33858-VUF	O-ring, #8
18.	1	41117-VUP	Refrigerant Oil

Checked By: _____
Packed By: _____
Date: _____

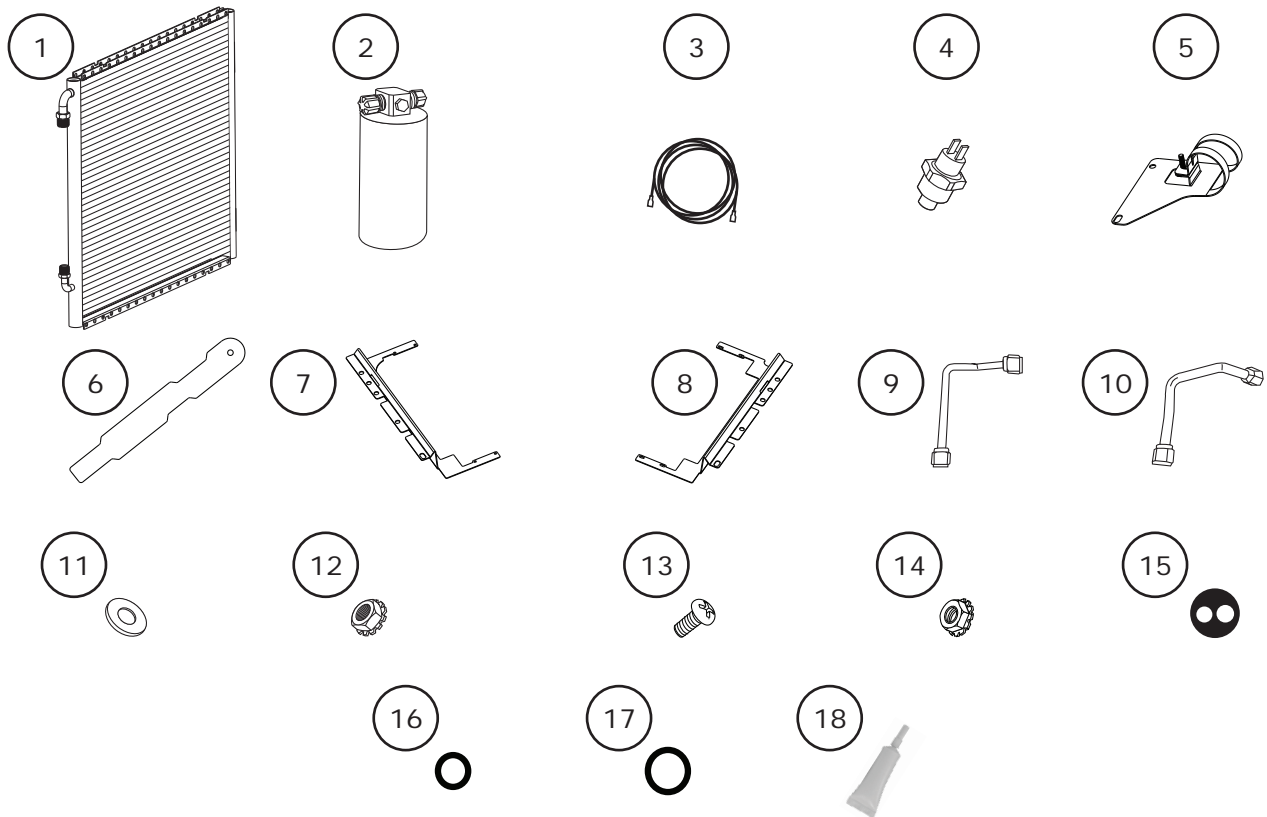

**NOTE: Images may not depict actual parts and quantities.
Refer to packing list for actual parts and quantities.**