

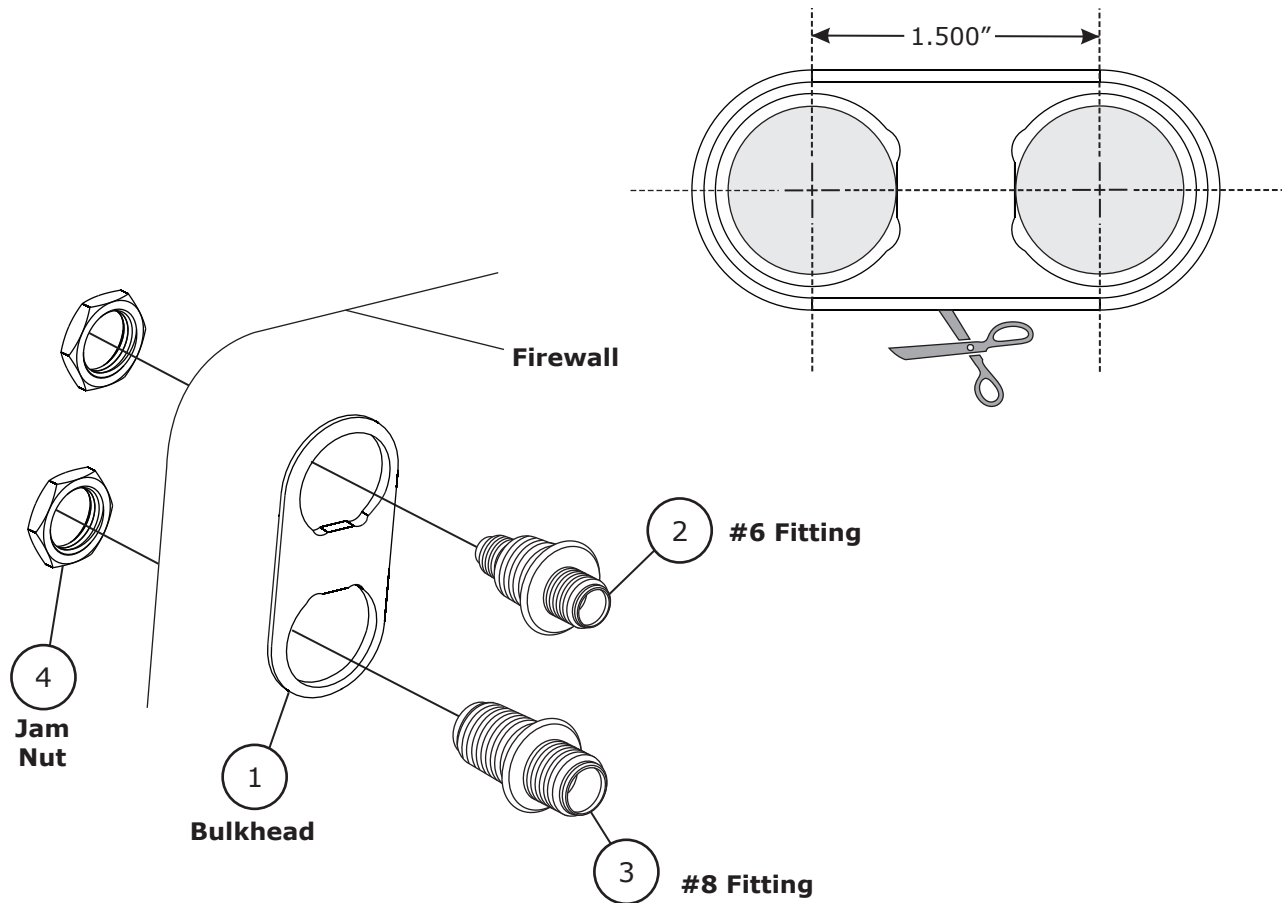

www.vintageair.com

# Installation Instructions: 2-Way Inline #6 - #8 Streamline Bulkhead (382680-MBA)

1. Cut out the bulkhead template and locate where you would like to place your bulkhead.
2. Level and tape the bulkhead template into place. Use a small center punch and mark holes.
3. Drill (2) 7/8" holes for the bulkhead fittings. Install the bulkhead with fittings as shown. **NOTE: Fittings may be arranged in any configuration.**



**NOTE: Due to printing variances, measure the line below before using this template. If template is scaled properly, the line should measure 6 inches.**



## Packing List:

No.	Qty.	Part No.	Description
1.	1	382300-MBQ	Inline Bulkhead Plate, 2-Way
2.	1	334006-VOR	Bulkhead Fitting, #6, Male
3.	1	334008-VOR	Bulkhead Fitting, #8, Male
4.	2	186079	Jam Nut, 7/8-14

Checked By: \_\_\_\_\_  
Packed By: \_\_\_\_\_  
Date: \_\_\_\_\_