

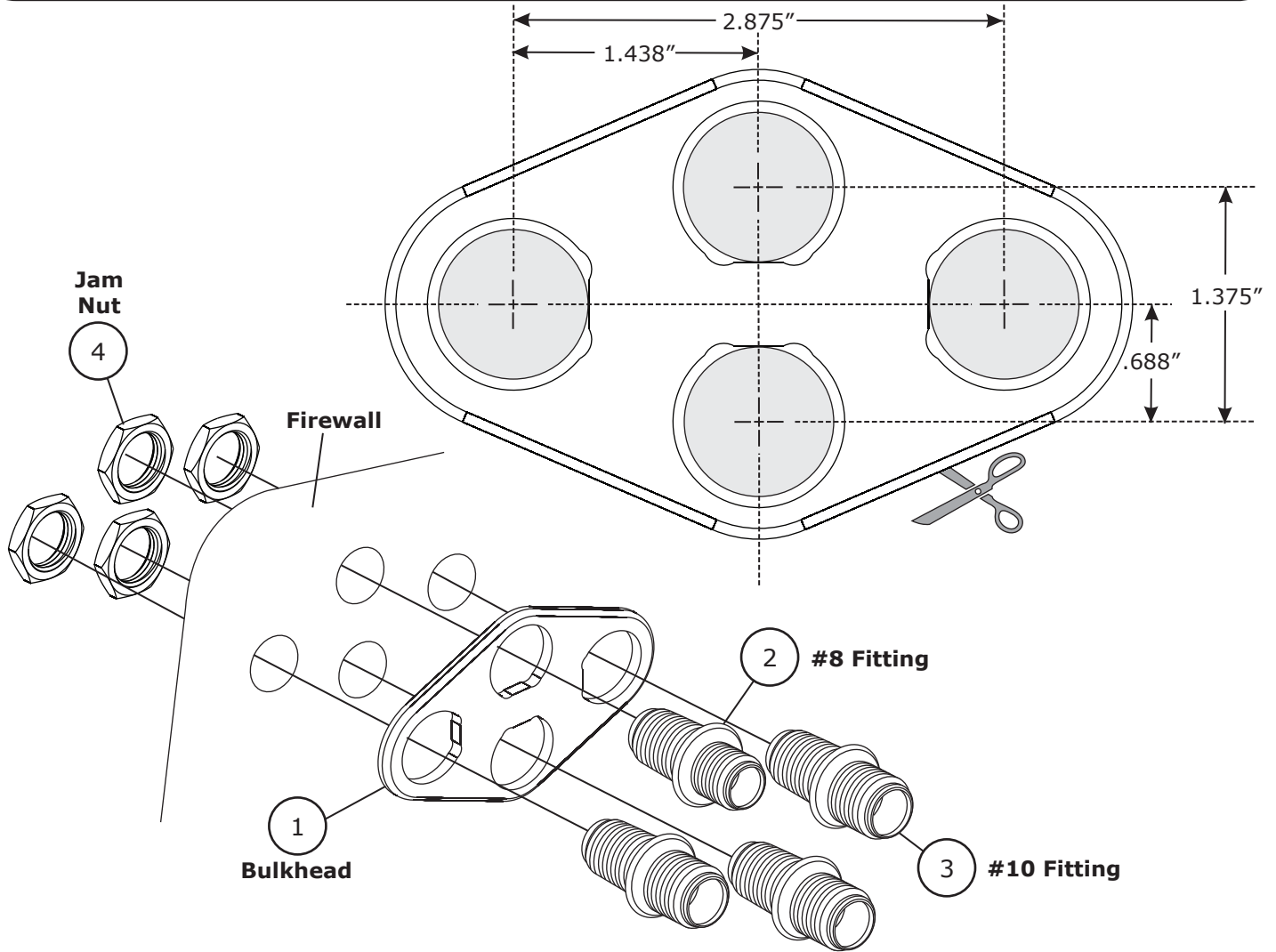

www.vintageair.com

Installation Instructions: 4-Way Diamond #8 - #10 Black Streamline Bulkhead (389801)

1. Cut out the bulkhead template and locate where you would like to place your bulkhead.
2. Level and tape the bulkhead template into place. Use a small center punch and mark holes.
3. Drill (4) 7/8" holes for the bulkhead fittings. Install the bulkhead with fittings as shown. **NOTE: Fittings may be arranged in any configuration.**



NOTE: Due to printing variances, measure the line below before using this template. If template is scaled properly, the line should measure 6 inches.

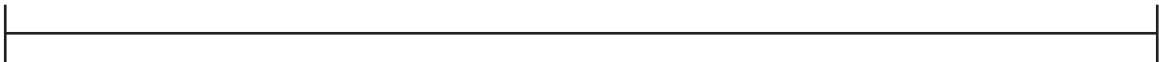

Packing List:

No.	Qty.	Part No.	Description
1.	1	388900	Diamond Bulkhead Plate, 4-Way, Black
2.	1	389908	Bulkhead Fitting, #8, Male, Black
3.	3	389910	Bulkhead Fitting, #10, Male, Black
4.	4	186079	Jam Nut, 7/8-14

Checked By: _____
Packed By: _____
Date: _____