

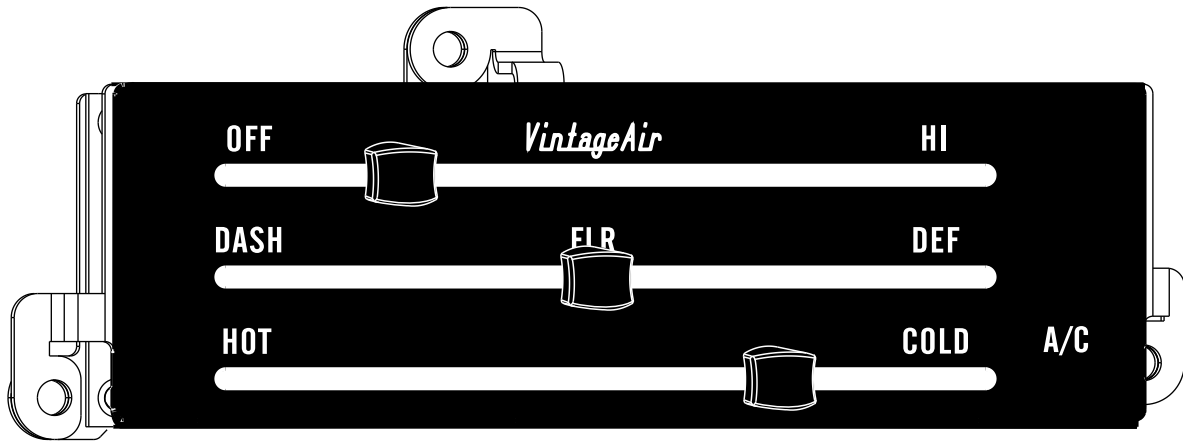

an ISO 9001:2015 Registered Company

# 1977-82 Chevrolet Corvette

Control Panel Kit  
(473043)



18865 Goll St. San Antonio, TX 78266  
Phone: 800-862-6658  
Sales: [sales@vintageair.com](mailto:sales@vintageair.com)  
Tech Support: [tech@vintageair.com](mailto:tech@vintageair.com)  
[www.vintageair.com](http://www.vintageair.com)



[www.vintageair.com](http://www.vintageair.com)

# Table of Contents

Cover.....	1
Table of Contents.....	2
Packing List/Parts Disclaimer.....	3
OEM Control Panel Removal.....	4
Control Panel Installation.....	5
Wiring Diagram.....	6
Operation of Controls.....	7
Packing List.....	8



www.vintageair.com

## Packing List: Control Panel Kit (473043)

No.	Qty.	Part No.	Description
1.	1	473044	Control Panel Assembly
2.	1	232007-VUR	Control Harness, Gen IV Universal

**\*\* Before beginning installation, open all packages and check contents of shipment. Please report any shortages directly to Vintage Air within 15 days. After 15 days, Vintage Air will not be responsible for missing or damaged items.**

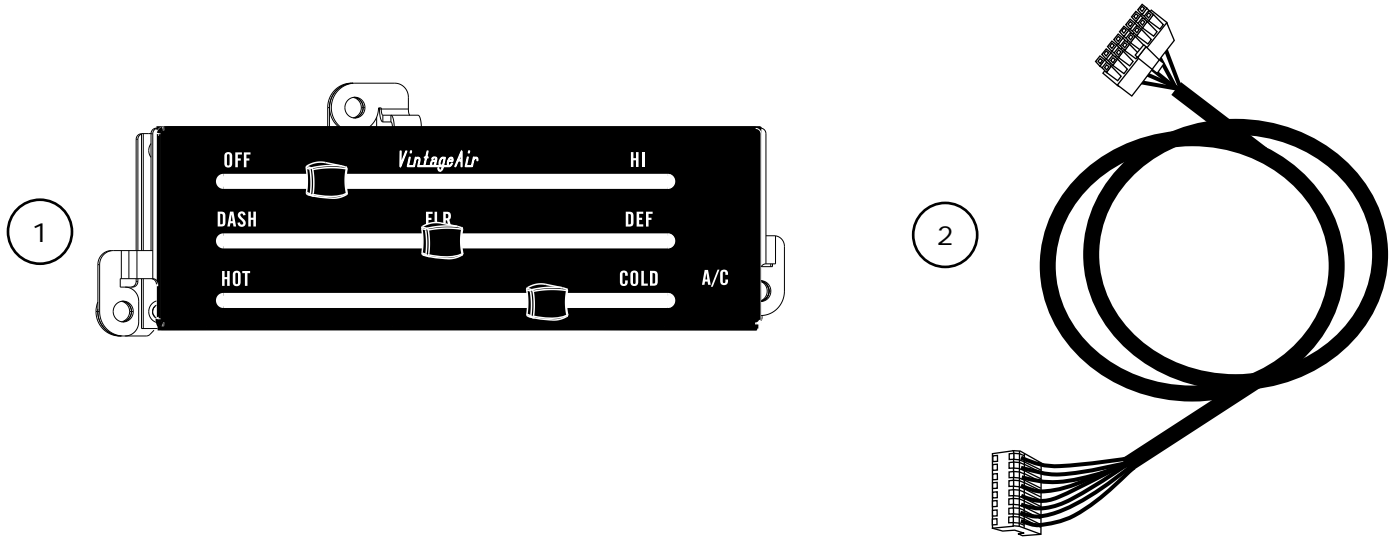

**NOTE: Images may not depict actual parts and quantities.  
Refer to packing list for actual parts and quantities.**



www.vintageair.com

## OEM Control Panel Removal

1. Disconnect the cables and wires from behind the OEM controls.
2. Remove the center console from the vehicle (See Photo 1, below).
3. Remove the (3) OEM screws from the back side of the console and remove the control panel (See Photo 2, below) (discard).



Photo 1

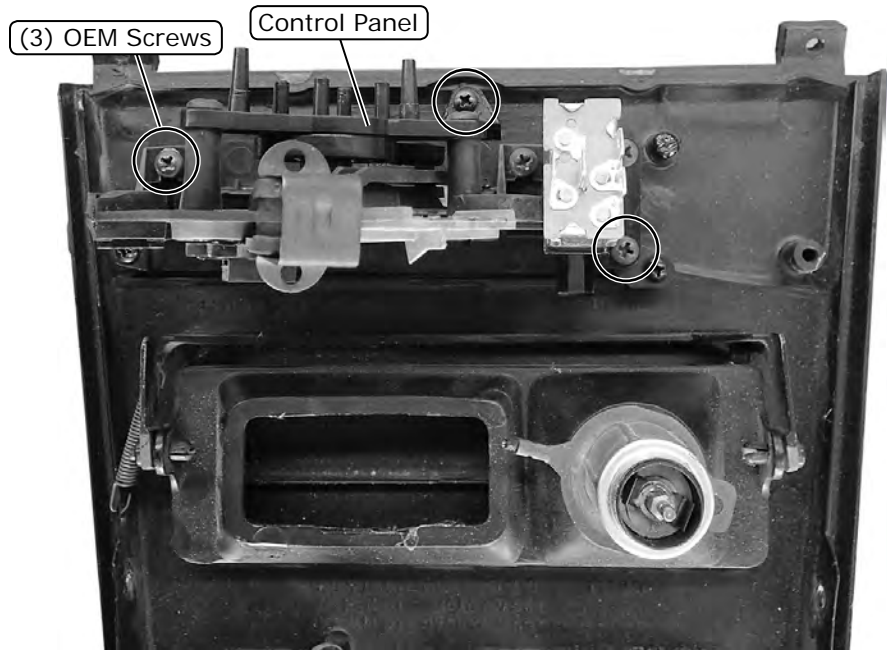

Photo 2



www.vintageair.com

## Control Panel Installation

1. Install the new control panel into the opening of the console, and tighten the (3) #8 x 1/2" screws provided with the control panel (See Photo 1, below). **NOTE: Do not overtighten the mounting screws.**
2. Plug the control harness into the ECU module on the sub case as shown in Photo 2, below.

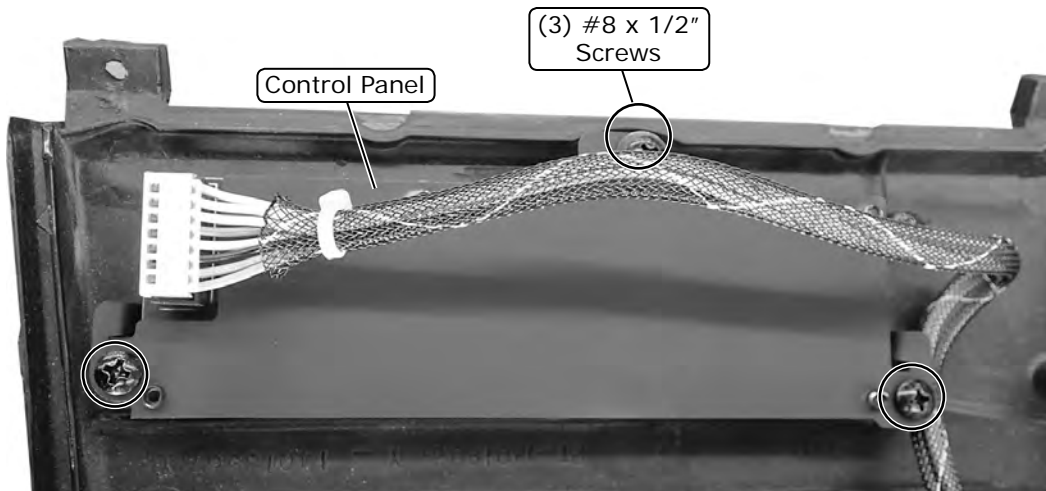

Photo 1



Photo 2

**NOTE:** When using Vintage Air supplied control panel, connect the tan wire from the Gen IV evaporator wiring harness (232600-VUA) to the factory dash lights to enable panel backlighting.



www.vintageair.com

# Wiring Diagram

## 232007-VUR

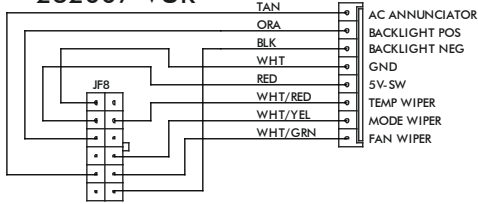

VIEWED FROM WIRE SIDE

## 232002-VUA

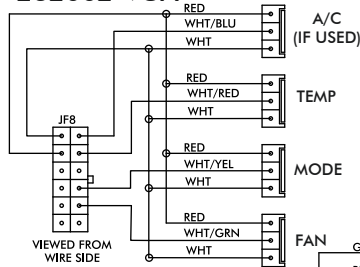

VIEWED FROM WIRE SIDE

## GEN IV ECU

GEN IV WIRING DIAGRAM  
REV E, 10/6/2017

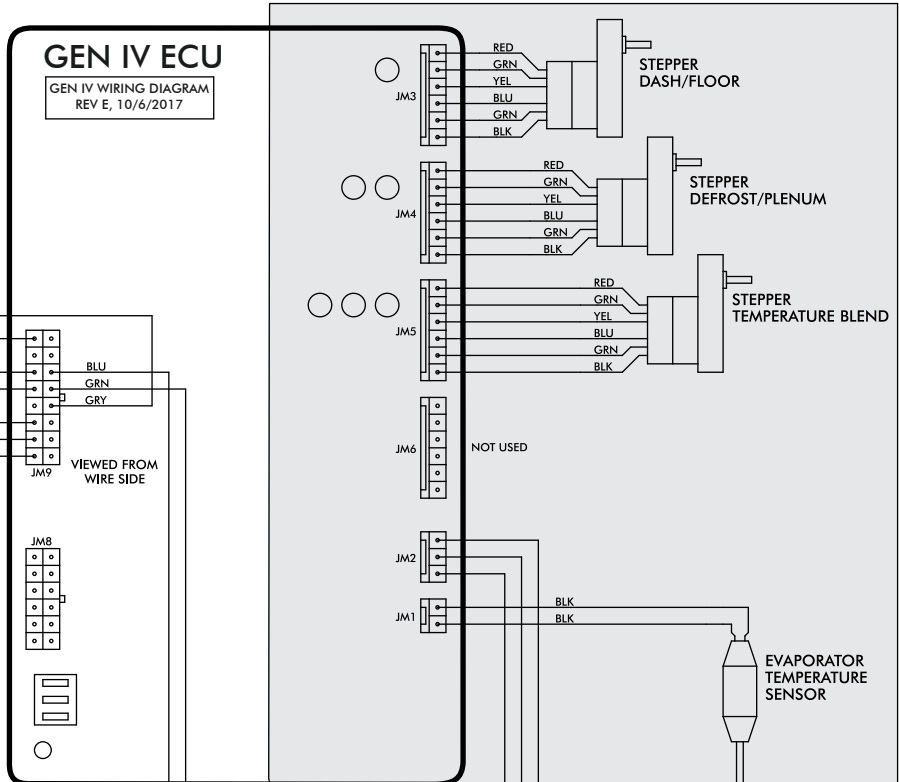

PRE-WIRED

### PROGRAM

N/A  
 \* DASH LAMP (IF USED)  
 \*\*\* WIDE OPEN THROTTLE SWITCH (OPTIONAL)

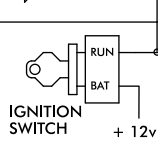

IGNITION SWITCH + 12v

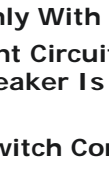
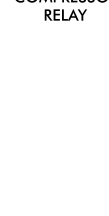
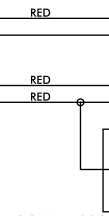
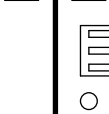
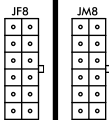
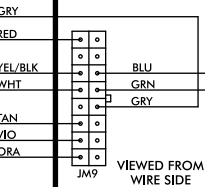
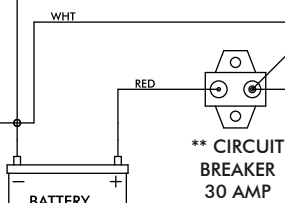

NOTE: = CHASSIS GROUND

\* Dash Lamp Is Used Only With Type 232007-VUR Harness.

\*\* Warning: Always Mount Circuit Breaker As Close to the Battery As Possible. (NOTE: Wire Between Battery and Circuit Breaker Is Unprotected and Should Be Carefully Routed to Avoid a Short Circuit).

\*\*\* Wide Open Throttle Switch Contacts Close Only at Full Throttle, Which Disables A/C Compressor.



www.vintageair.com

## Operation of Controls

On Gen IV systems with three lever/knob controls, the temperature control toggles between heat and A/C operations. To activate A/C, move the temperature lever/knob all the way to cold and then back it off to the desired vent temperature. For heat operation, move the temperature lever/knob all the way to hot and then adjust to the desired vent temperature. The blower will momentarily change speed, each time you toggle between operations, to indicate the change.

### Blower Speed

This lever/knob controls blower speed, from OFF to HI.

### Mode Control

This lever/knob controls the mode positions, from DEFROST to FLOOR to DASH, with a blend in between.

### Temperature Control

This lever/knob controls the temperature, from HOT to COLD.

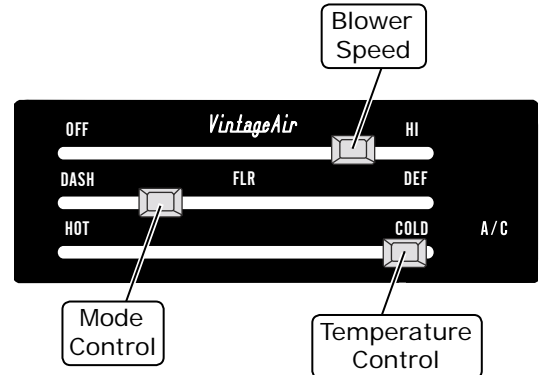

## A/C Operation

### Blower Speed

Adjust to desired speed.

### Mode Control

Adjust to desired mode position (DASH position recommended).

### Temperature Control

For A/C operation, adjust to coldest position to engage compressor (Adjust between HOT and COLD to reach desired temperature).



## Heat Operation

### Blower Speed

Adjust to desired speed.

### Mode Control

Adjust to desired mode position (FLOOR position recommended).

### Temperature Control

For maximum heating, adjust to hottest position (Adjust between HOT and COLD to reach desired temperature).



## Defrost/De-fog Operation

### Blower Speed

Adjust to desired speed.

### Temperature Control

Adjust to desired temperature.

### Mode Control

Adjust to DEFROST position for maximum defrost, or between FLOOR and DEFROST positions for a bi-level blend (Compressor is automatically engaged).





www.vintageair.com

# Packing List: Control Panel Kit (473043)

No.	Qty.	Part No.	Description
1.	1	473044	Control Panel Assembly
2.	1	232007-VUR	Control Harness, Gen IV Universal

Checked By: \_\_\_\_\_  
Packed By: \_\_\_\_\_  
Date: \_\_\_\_\_

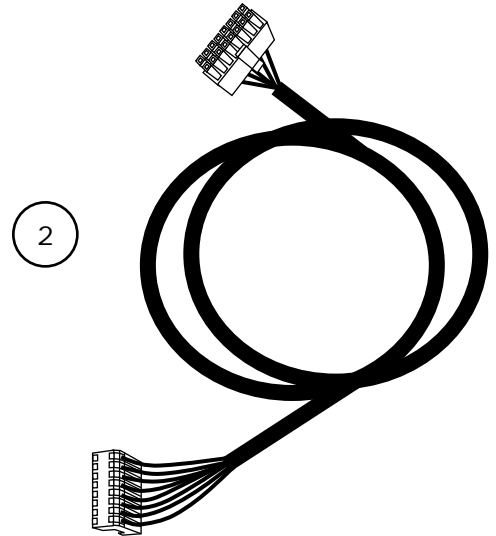
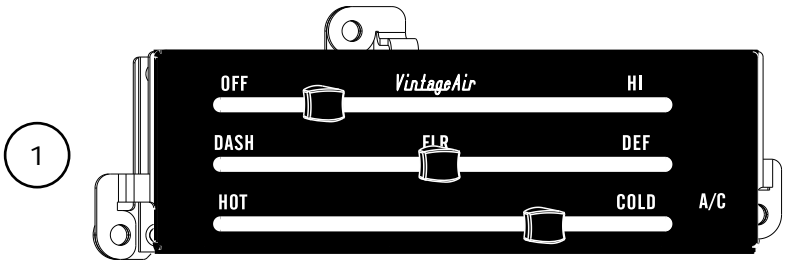

**NOTE: Images may not depict actual parts and quantities.  
Refer to packing list for actual parts and quantities.**