

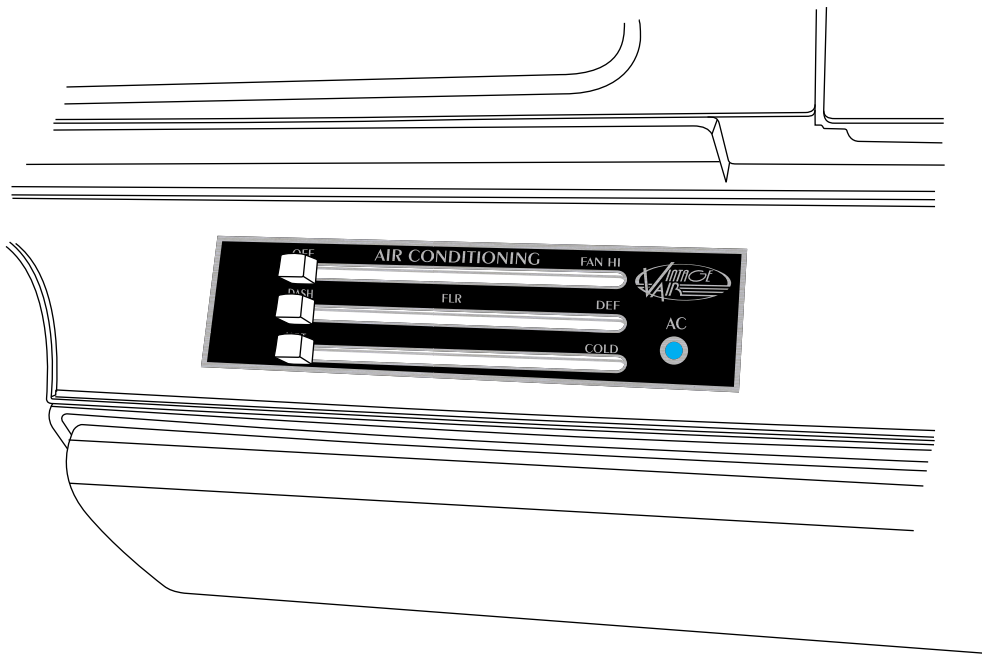

an ISO 9001:2015 Registered Company

# 1968-69 Oldsmobile Cutlass

## Control Panel Conversion Kit (473079)



18865 Goll St. San Antonio, TX 78266  
Phone: 800-862-6658  
Sales: [sales@vintageair.com](mailto:sales@vintageair.com)  
Tech Support: [tech@vintageair.com](mailto:tech@vintageair.com)  
[www.vintageair.com](http://www.vintageair.com)



[www.vintageair.com](http://www.vintageair.com)

# Table of Contents

Cover.....	1
Table of Contents.....	2
Packing List/Parts Disclaimer.....	3
OEM Control Panel Removal.....	4
Control Panel & Control Harness Installation.....	5
Wiring Diagram.....	6
Operation of Controls.....	7
Control Panel Packing List.....	8



www.vintageair.com

## Packing List: Control Panel Kit (473079)

No.	Qty.	Part No.	Description
1.	1	473078	Control Panel Assembly
2.	1	232007-VUR	Control Harness, Gen IV Universal

**\*\* Before beginning installation, open all packages and check contents of shipment. Please report any shortages directly to Vintage Air within 15 days. After 15 days, Vintage Air will not be responsible for missing or damaged items.**

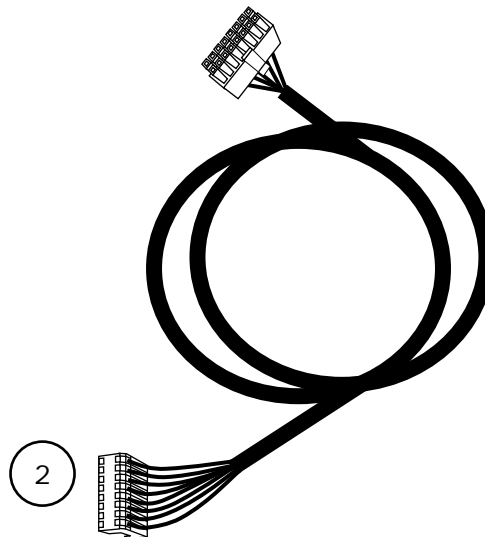
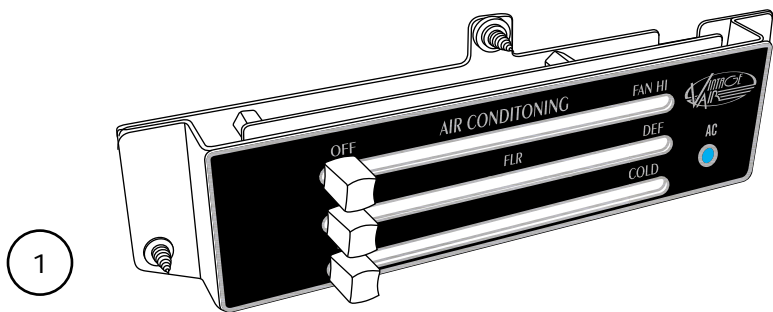

**NOTE: Images may not depict actual parts and quantities. Refer to packing list for actual parts and quantities.**



www.vintageair.com

## OEM Control Panel Removal

### Perform the Following:

1. Disconnect the battery ground cable.
2. Disconnect all wires and cables from the control panel. **NOTE: When using a Vintage Air supplied control panel, connect the tan wire from the Gen IV Evaporator wiring harness (232600-VUA) to the factory dash lights to enable panel backlighting.**
3. Remove the control panel from the dash by removing (3) OEM screws.

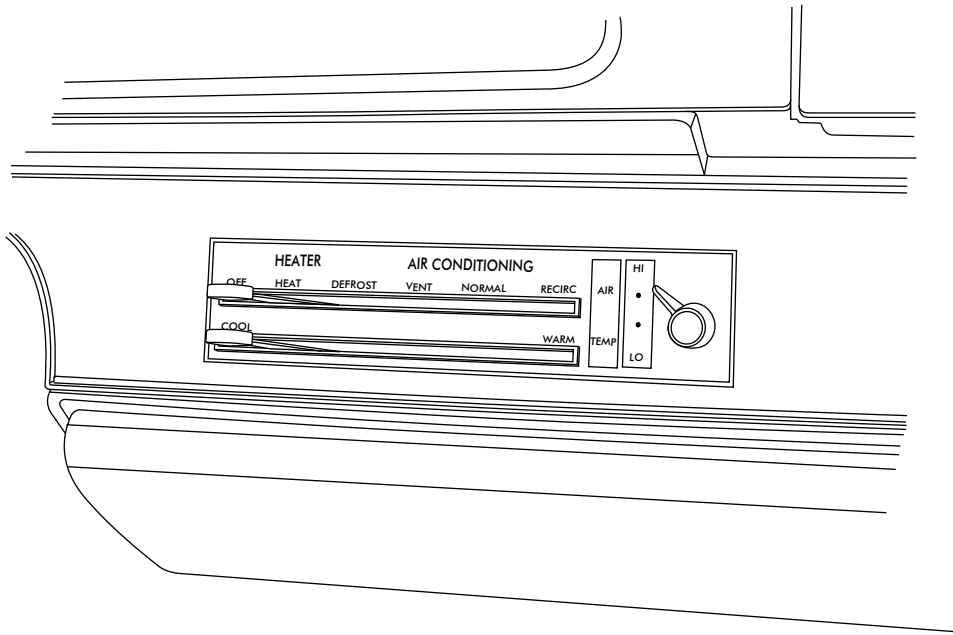

Figure 1



www.vintageair.com

## Control Panel & Control Harness Installation

1. Install the control panel assembly into the OEM mounting location. **NOTE: Take care not to scuff the control panel face during installation (See Figure 2, below).**
2. The control panel face is intended to position just shy of flush of the instrument panel. **NOTE: Remove the shimming washers as required to adjust the control panel flushness and accomodate variations in the factory dash tolerance.**
3. Plug the control panel harness into the ECU as shown in Figure 3, below. Plug the opposite end of the harness into the control panel PC board as shown in Figure 3, below.

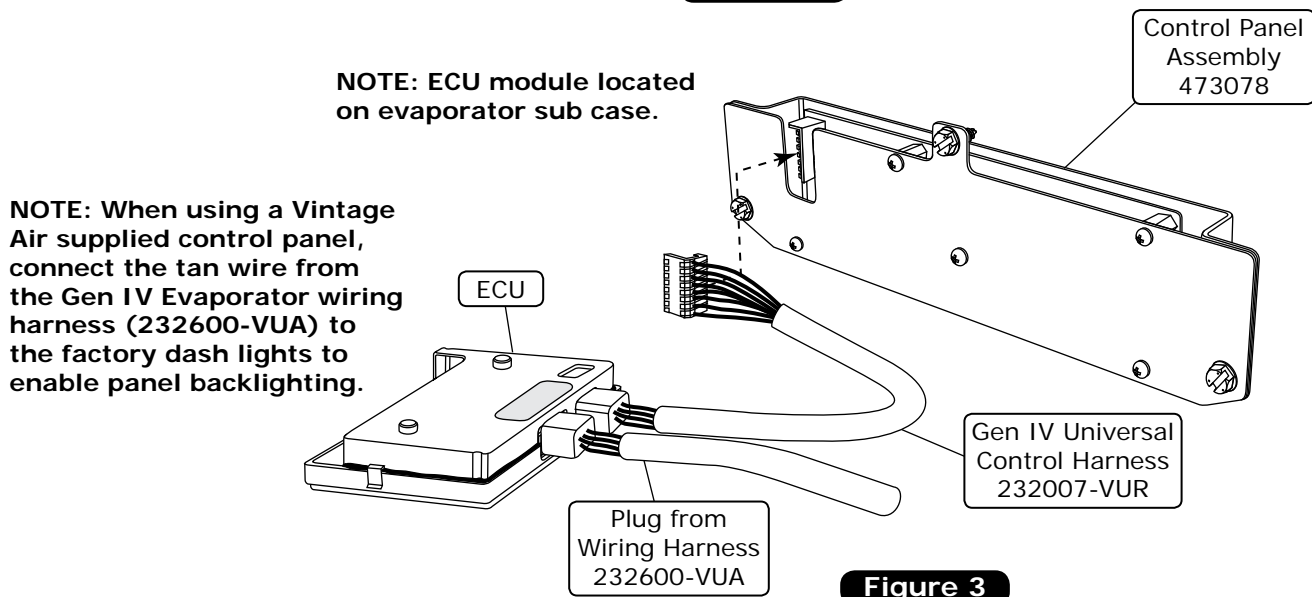
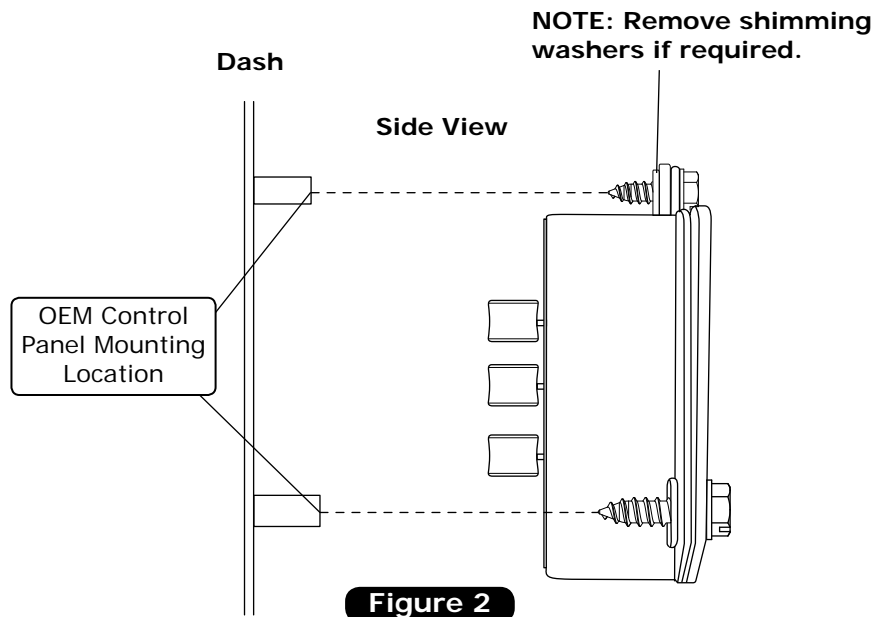



www.vintageair.com

# Wiring Diagram

## 232007-VUR

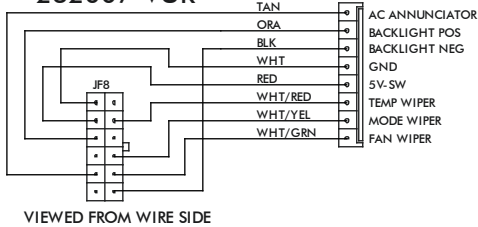

## 232002-VUA

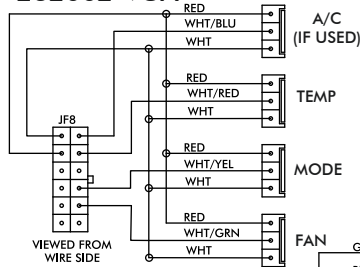

## GEN IV ECU

GEN IV WIRING DIAGRAM  
REV E, 10/6/2017

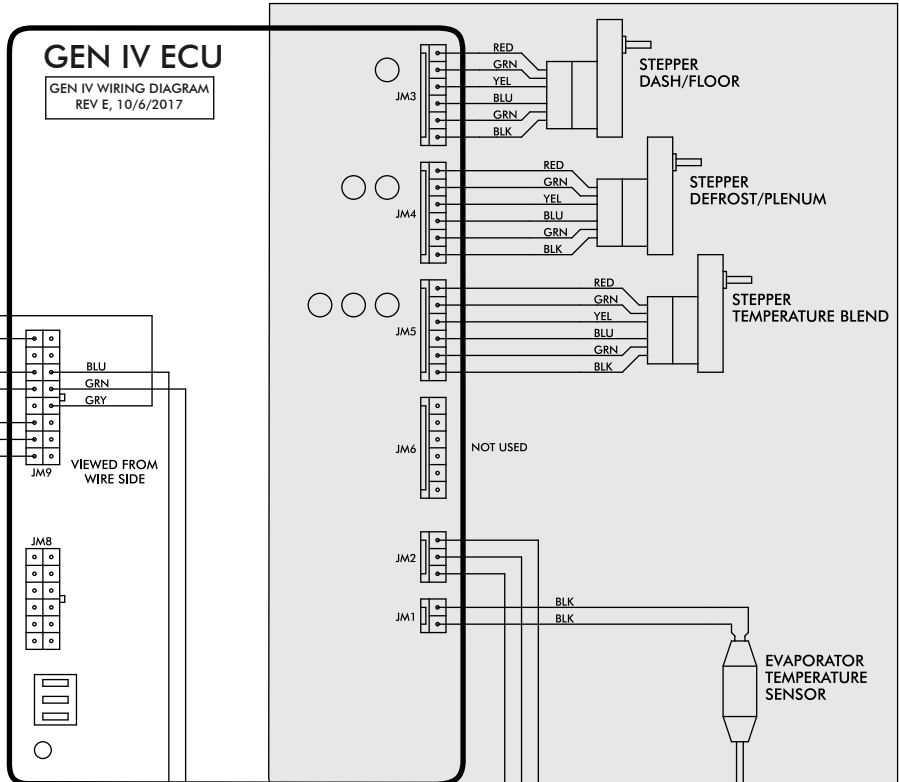

### PROGRAM

N/A  
\* DASH LAMP (IF USED)  
\*\*\* WIDE OPEN THROTTLE SWITCH (OPTIONAL)

IGNITION SWITCH + 12v

\*\* CIRCUIT BREAKER 30 AMP

COMPRESSOR RELAY

BINARY OR TRINARY SAFETY SWITCH

CMPR

HEATER CONTROL VALVE

NOTE: = CHASSIS GROUND

\* Dash Lamp Is Used Only With Type 232007-VUR Harness.

\*\* Warning: Always Mount Circuit Breaker As Close to the Battery As Possible. (NOTE: Wire Between Battery and Circuit Breaker Is Unprotected and Should Be Carefully Routed to Avoid a Short Circuit).

\*\*\* Wide Open Throttle Switch Contacts Close Only at Full Throttle, Which Disables A/C Compressor.



www.vintageair.com

## Operation of Controls

On Gen IV systems with three lever/knob controls, the temperature control toggles between heat and A/C operations. To activate A/C, move the temperature lever/knob all the way to cold and then back it off to the desired vent temperature. For heat operation, move the temperature lever/knob all the way to hot and then adjust to the desired vent temperature. The blower will momentarily change speed, each time you toggle between operations, to indicate the change.

### Blower Speed

This lever/knob controls blower speed, from OFF to HI.

### Mode Control

This lever/knob controls the mode positions, from DASH to FLOOR to DEFROST, with a blend in between.

### Temperature Control

This lever/knob controls the temperature, from HOT to COLD.

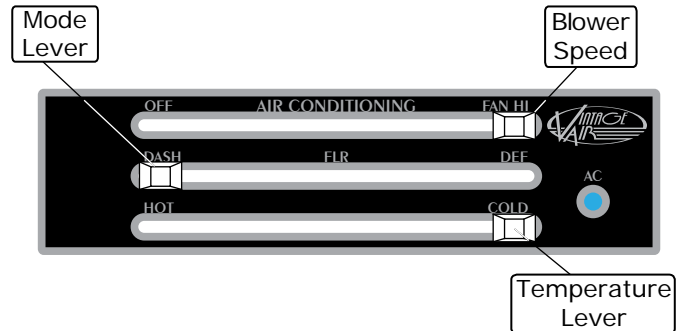

## A/C Operation

### Blower Speed

Adjust to desired speed.

### Mode Control

Adjust to desired mode position (DASH position recommended).

### Temperature Control

For A/C operation, adjust to coldest position to engage compressor (Adjust between HOT and COLD to reach desired temperature).

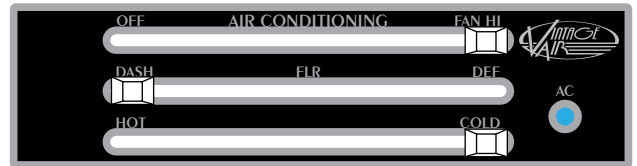

## Heat Operation

### Blower Speed

Adjust to desired speed.

### Mode Control

Adjust to desired mode position (FLOOR position recommended).

### Temperature Control

For maximum heating, adjust to hottest position (Adjust between HOT and COLD to reach desired temperature).

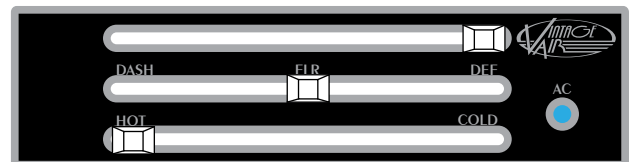

## Defrost/De-fog Operation

### Blower Speed

Adjust to desired speed.

### Temperature Control

Adjust to desired temperature.

### Mode Control

Adjust to DEFROST position for maximum defrost, or between FLOOR and DEFROST positions for a bi-level blend (Compressor is automatically engaged).

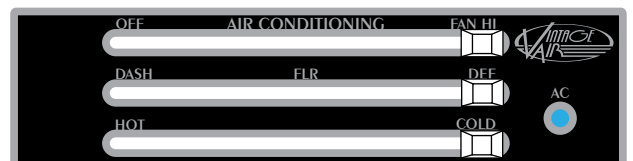



www.vintageair.com

# Packing List: Control Panel Kit (473079)

No.	Qty.	Part No.	Description
1.	1	473078	Control Panel Assembly
2.	1	232007-VUR	Control Harness, Gen IV Universal

Checked By: \_\_\_\_\_  
 Packed By: \_\_\_\_\_  
 Date: \_\_\_\_\_

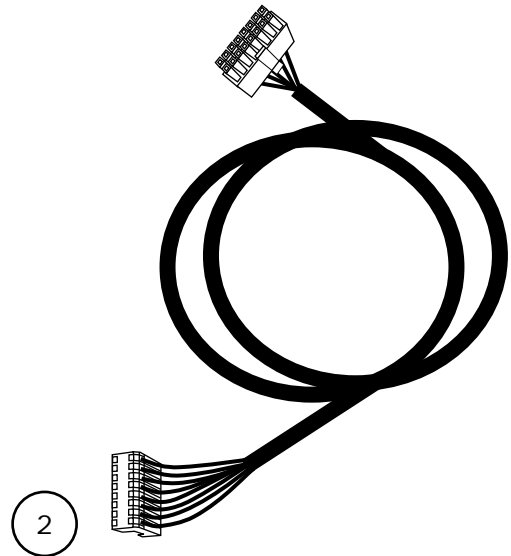
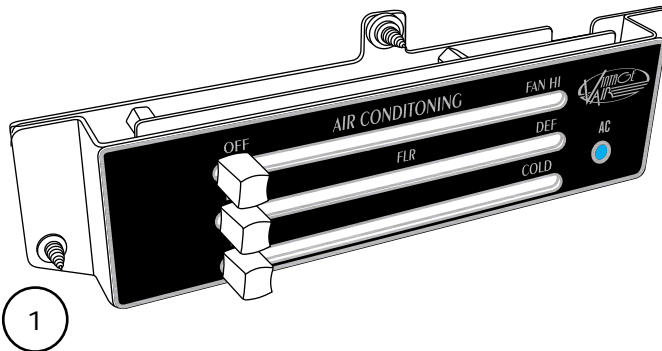

**NOTE: Images may not depict actual parts and quantities.  
 Refer to packing list for actual parts and quantities.**