

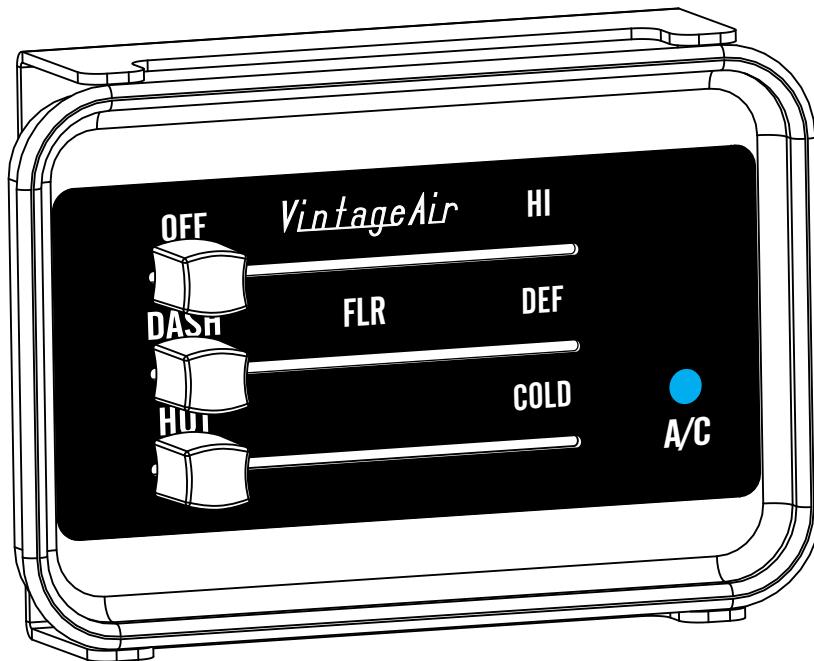

an ISO 9001:2015 Registered Company

1960-63 Chevrolet Pickup

Control Panel Kit (473262)



18865 Goll St. San Antonio, TX 78266
Phone: 800-862-6658
Sales: sales@vintageair.com
Tech Support: tech@vintageair.com
www.vintageair.com



www.vintageair.com

Table of Contents

Cover.....	1
Table of Contents.....	2
Packing List/Parts Disclaimer.....	3
Control Panel Installation.....	4
Wiring Diagram.....	5
Gen IV Wiring Connection Instructions.....	6
Operation of Controls.....	7
Packing List.....	8



www.vintageair.com

Packing List: Control Panel Kit (473262)

No.	Qty.	Part No.	Description
1.	1	493052	Control Panel
2.	1	232007-VUR	Control Harness, Gen IV Universal

**** Before beginning installation, open all packages and check contents of shipment. Please report any shortages directly to Vintage Air within 15 days. After 15 days, Vintage Air will not be responsible for missing or damaged items.**

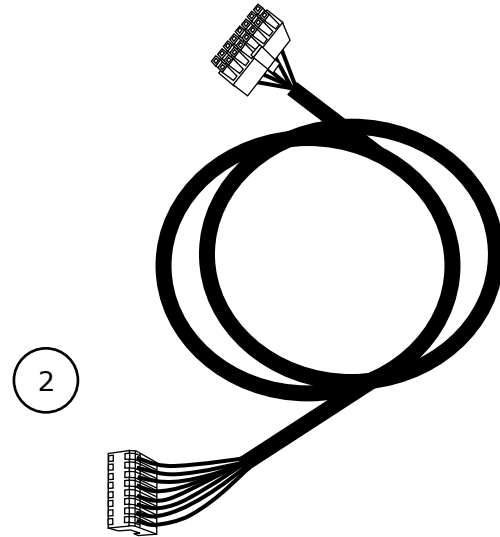
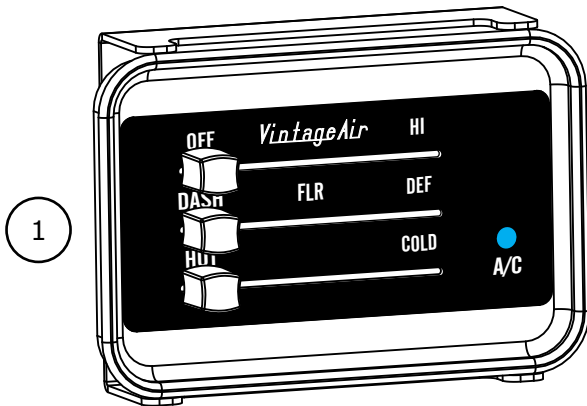

**NOTE: Images may not depict actual parts and quantities.
Refer to packing list for actual parts and quantities.**



www.vintageair.com

Control Panel Installation

1. Install the control panel assembly into the dash by placing the control panel bracket behind the dash and securing it to the 3-lever panel assembly using a 10-24 nylon locknut (See Figure 1, below).
2. Plug the control panel wiring harness into the control panel assembly and the ECU on evaporator as shown in Figure 2, below.
3. Wire according to wiring diagram on Pages 5 & 6.

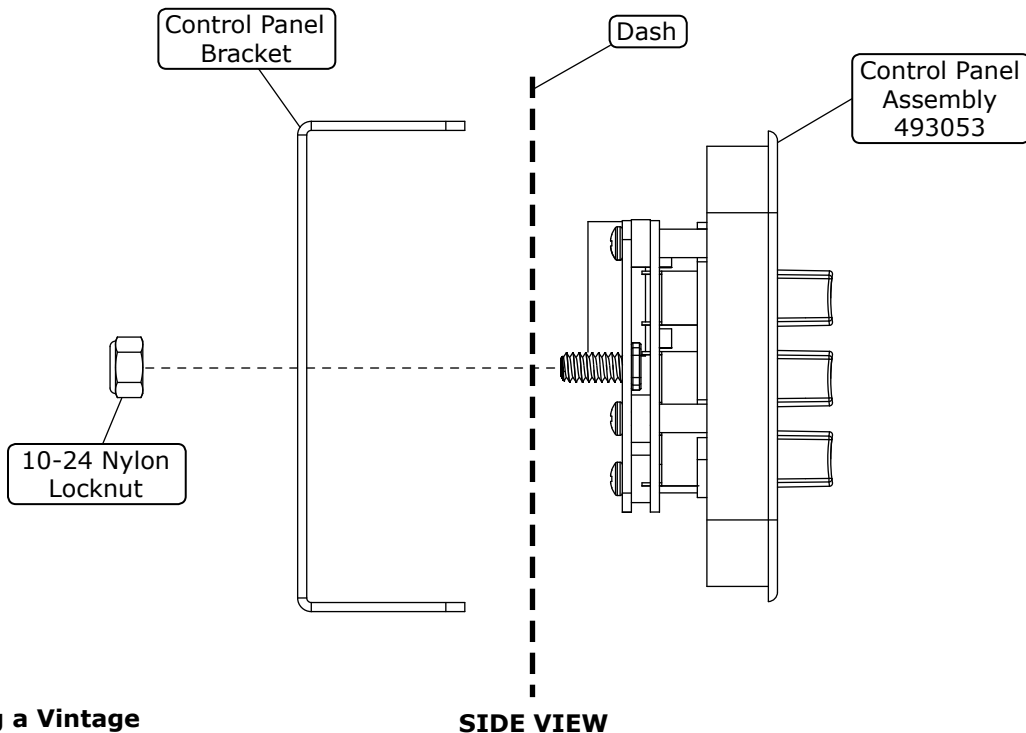

NOTE: When using a Vintage Air supplied control panel, connect the tan wire from the Gen IV Evaporator wiring harness (232600-VUA) to the factory dash lights to enable panel backlighting.

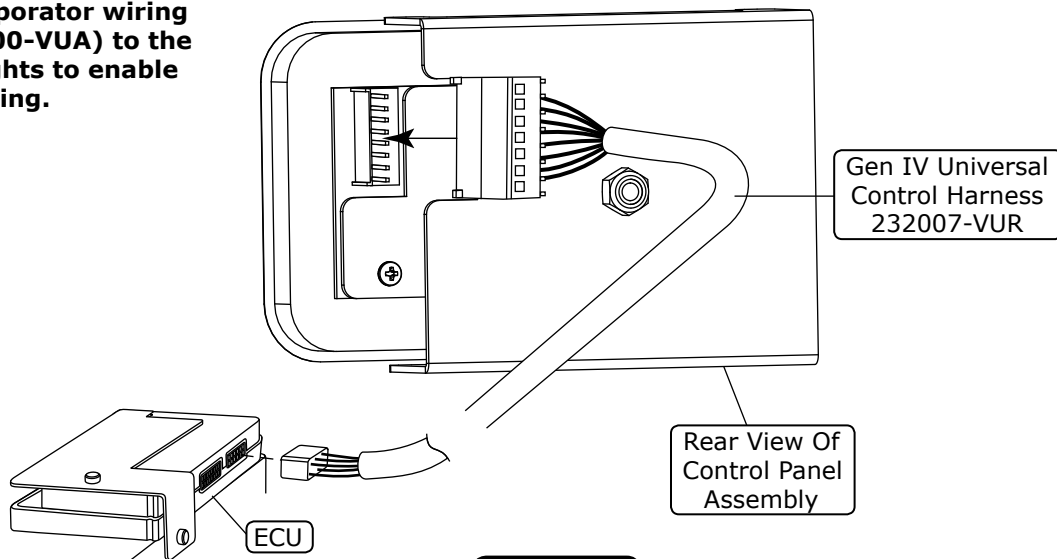

Figure 2



www.vintageair.com

Wiring Diagram

232007-VUR

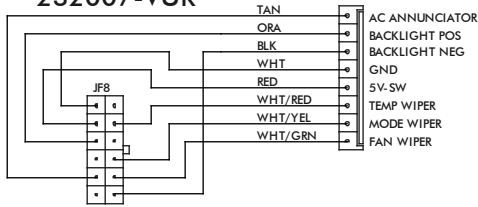

VIEWED FROM WIRE SIDE

232002-VUA

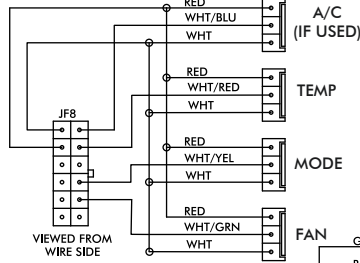

VIEWED FROM WIRE SIDE

GEN IV ECU

GEN IV WIRING DIAGRAM
REV E, 10/6/2017

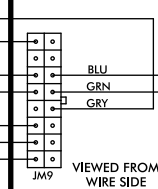

PROGRAM

N/A
* DASH LAMP (IF USED)
*** WIDE OPEN THROTTLE SWITCH (OPTIONAL)

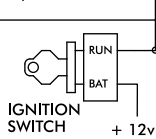

IGNITION SWITCH + 12v

** CIRCUIT BREAKER 30 AMP

COMPRESSOR RELAY

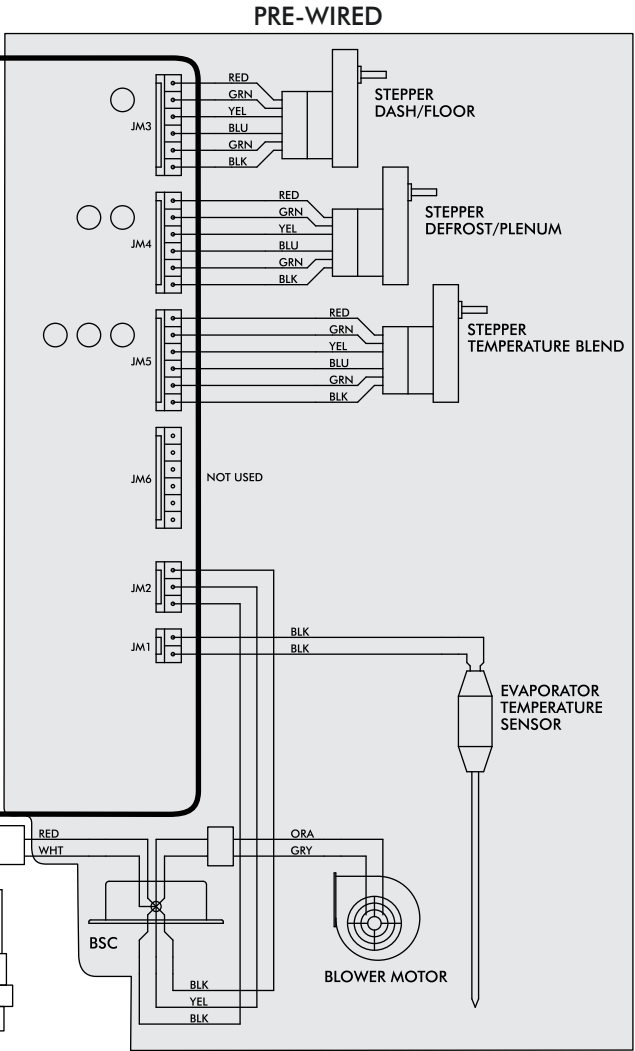

NOTE: = CHASSIS GROUND

* Dash Lamp Is Used Only With Type 232007-VUR Harness.

** Warning: Always Mount Circuit Breaker As Close to the Battery As Possible. (NOTE: Wire Between Battery and Circuit Breaker Is Unprotected and Should Be Carefully Routed to Avoid a Short Circuit).

*** Wide Open Throttle Switch Contacts Close Only at Full Throttle, Which Disables A/C Compressor.



www.vintageair.com
WIRING
HARNESS

Gen IV Wiring Connection Instruction

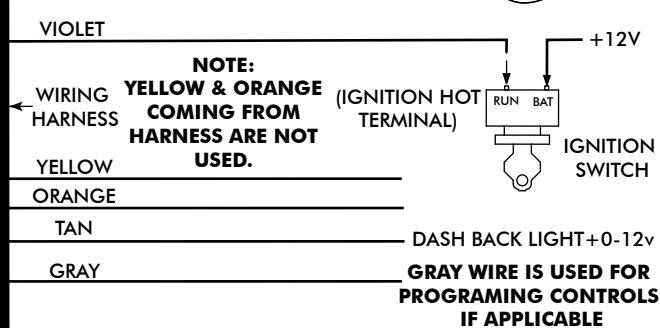
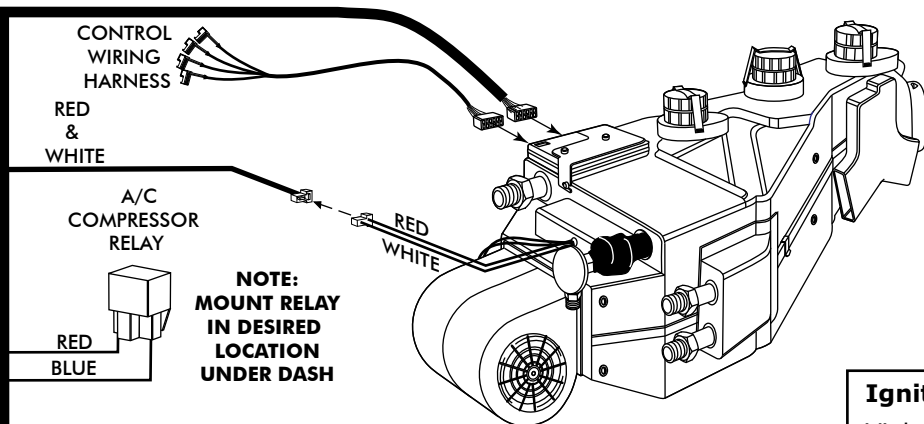

Ignition Switch:
Violet 12V Ign Switch Source (Key On Accessory) Position Must Be Switched.

Dash Light:
When Using A Vintage Air Supplied Control Panel, Connect The Tan Wire From The Gen IV Evaporator Wiring Harness To The Factory Dash Lights To Enable Panel Backlighting.

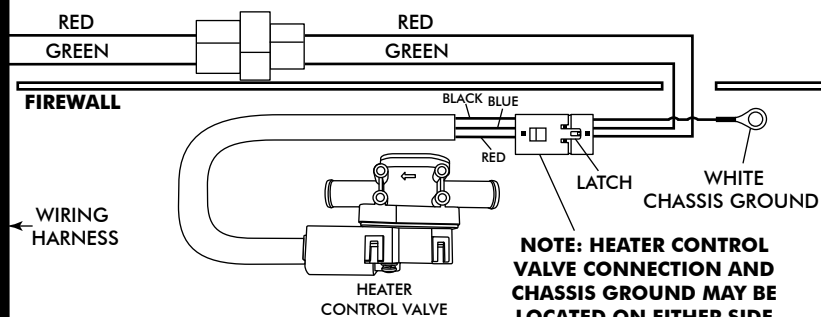

Heater Control Valve:
Install With Servo Motor Facing Down, As Shown. Note Flow Direction Arrow Molded Into Valve Body, And Install Accordingly.

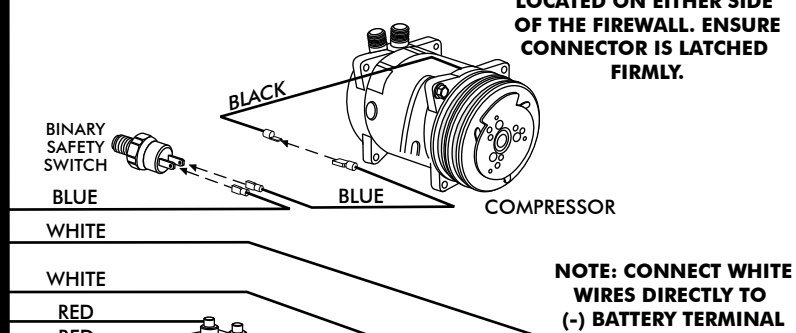

Binary/Trinary & Compressor:
Binary: Connect As Shown (Typical Compressor Wiring). Be Sure Compressor Body Is Grounded.
Trinary Switch: Connect According To Trinary Switch Wiring Diagram.

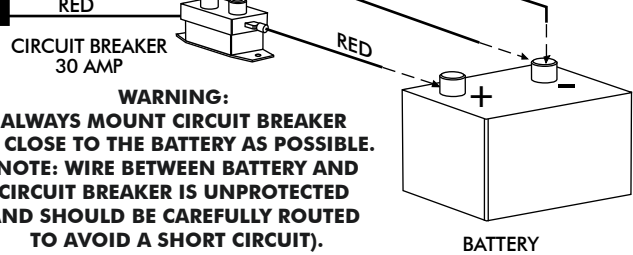

Circuit Breaker/Battery:
White **Must** Run To (-) Battery. Red May Run To (+) Battery Or Starter. Mount Circuit Breaker As Close to Battery As Possible.



www.vintageair.com

Operation of Controls

On Gen IV systems with three lever/knob controls, the temperature control toggles between heat and A/C operations. To activate A/C, move the temperature lever/knob all the way to cold and then back it off to the desired vent temperature. For heat operation, move the temperature lever/knob all the way to hot and then adjust to the desired vent temperature. The blower will momentarily change speed, each time you toggle between operations, to indicate the change.

Blower Speed

This lever/knob controls blower speed, from OFF to HI.

Mode Control

This lever/knob controls the mode positions, from DASH to FLOOR to DEFROST, with a blend in between.

Temperature Control

This lever/knob controls the temperature, from HOT to COLD.

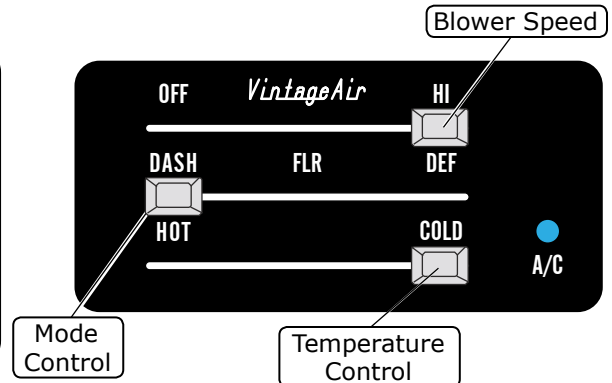

A/C Operation

Blower Speed

Adjust to desired speed.

Mode Control

Adjust to desired mode position (DASH position recommended).

Temperature Control

For A/C operation, adjust to coldest position to engage compressor (Adjust between HOT and COLD to reach desired temperature).

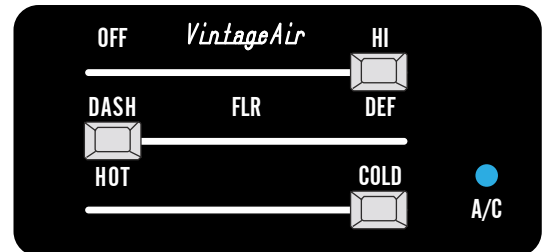

Heat Operation

Blower Speed

Adjust to desired speed.

Mode Control

Adjust to desired mode position (FLOOR position recommended).

Temperature Control

For maximum heating, adjust to hottest position (Adjust between HOT and COLD to reach desired temperature).

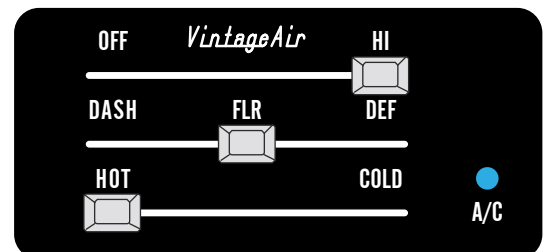

Defrost/De-fog Operation

Blower Speed

Adjust to desired speed.

Temperature Control

Adjust to desired temperature.

Mode Control

Adjust to DEFROST position for maximum defrost, or between FLOOR and DEFROST positions for a bi-level blend (Compressor is automatically engaged).

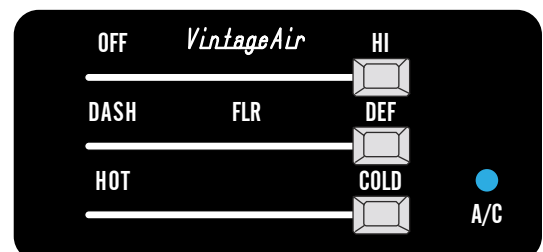



www.vintageair.com

Packing List: Control Panel Kit (473262)

No.	Qty.	Part No.	Description
1.	1	493052	Control Panel
2.	1	232007-VUR	Control Harness, Gen IV Universal

Checked By: _____
Packed By: _____
Date: _____

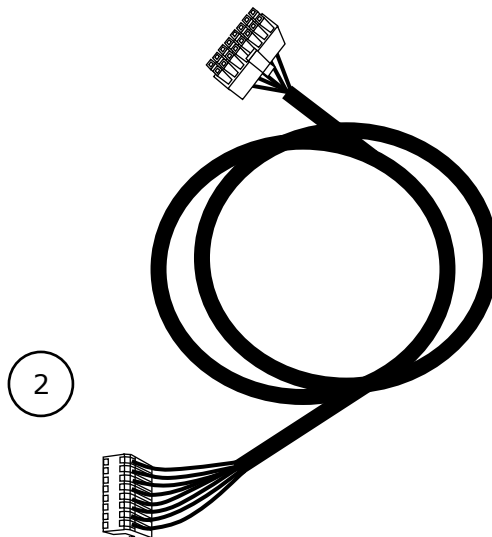
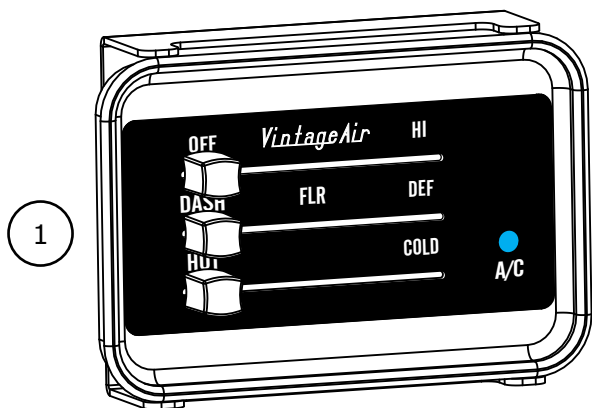

**NOTE: Images may not depict actual parts and quantities.
Refer to packing list for actual parts and quantities.**