

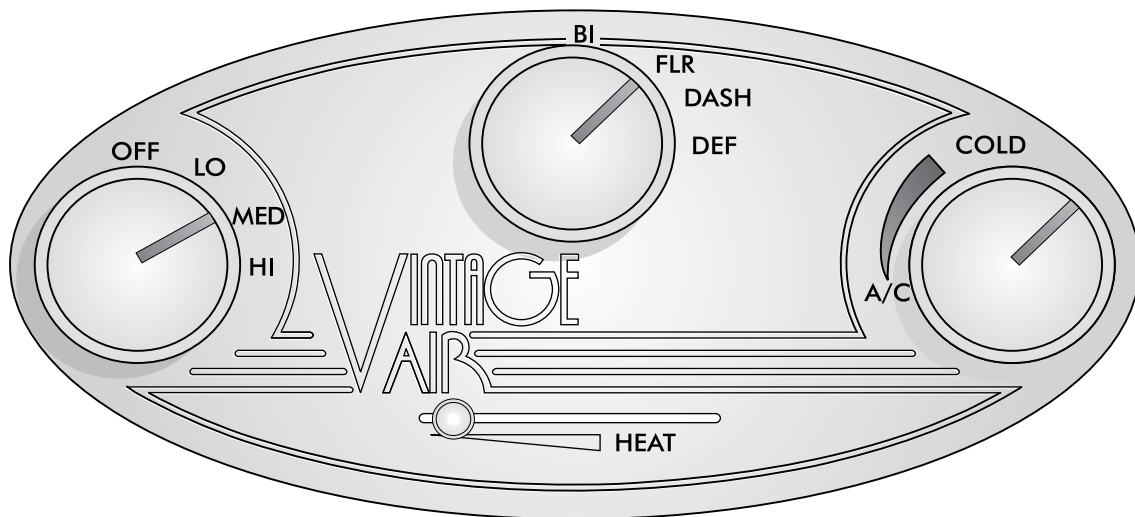

an ISO 9001:2015 Registered Company

# Streamline

Gen II Oval Control Panel  
Black  
(481005)



18865 Goll St. San Antonio, TX 78266  
Phone: 800-862-6658  
Sales: [sales@vintageair.com](mailto:sales@vintageair.com)  
Tech Support: [tech@vintageair.com](mailto:tech@vintageair.com)  
[www.vintageair.com](http://www.vintageair.com)



[www.vintageair.com](http://www.vintageair.com)

# Table of Contents

Cover.....	1
Table of Contents.....	2
Packing List/Parts Disclaimer.....	3
Streamline Control Panel Template, Control Panel Installation.....	4
Control Panel Installation (Cont.), Streamline Control Panel Wiring Diagram.....	5
Streamline Operation of Controls.....	6
Wiring Diagram: Gen II ComPac/Super Units.....	7
Wiring Diagram: Gen II Mini Units.....	8
Important Notice, Air Conditioning Adjustments, Adjusting A/C Thermostat.....	9
Packing List.....	10



www.vintageair.com

## Packing List: Control Panel Kit (481005)

No.	Qty.	Part No.	Description
1.	1	11092-VUT	Thermostat, 48", Adjustable Rotary
2.	1	11212-SUA	Slide Pot with Pigtail
3.	2	11458-VUS	Switch, 3-Speed Rotary
4.	3	18145-VUB	Nyloc Nut, 10-24
5.	6	18157-VUB	Shaft Nut, 7/16"
6.	2	18199-VUB	Screw, 8-32 x 3/8", Hex
7.	3	18260-VUB	Nut, 10-24 with Star Washer
8.	2	18262-VUB	Star Washer, #8
9.	3	18414-VUB	Set Screw, 10-24 x 3/4"
10.	3	20557-VUP	Light Bulb
11.	1	23120-VUW	Ring Terminal, #10 (22/18)
12.	1	23122-VUW	Spade Terminal, 1/4" (22/18)
13.	3	33138-VUI	Grommet, 1/4"
14.	1	492023	Panel Face, Streamline, Black
15.	3	492033	Knob Assembly, Streamline, Black Anodized
16.	1	492032	Slide Pot Knob, Streamline, Black
17.	3	64123-VUB	Bracket, Streamline Control Panel
18.	2	23123-VUW	Buddy Clip
19.	2	23139-VUW	Jumper Wire, 6"
20.	1	648178	Bracket, Rear Backing Plate

**\*\* Before beginning installation, open all packages and check contents of shipment. Please report any shortages directly to Vintage Air within 15 days. After 15 days, Vintage Air will not be responsible for missing or damaged items.**

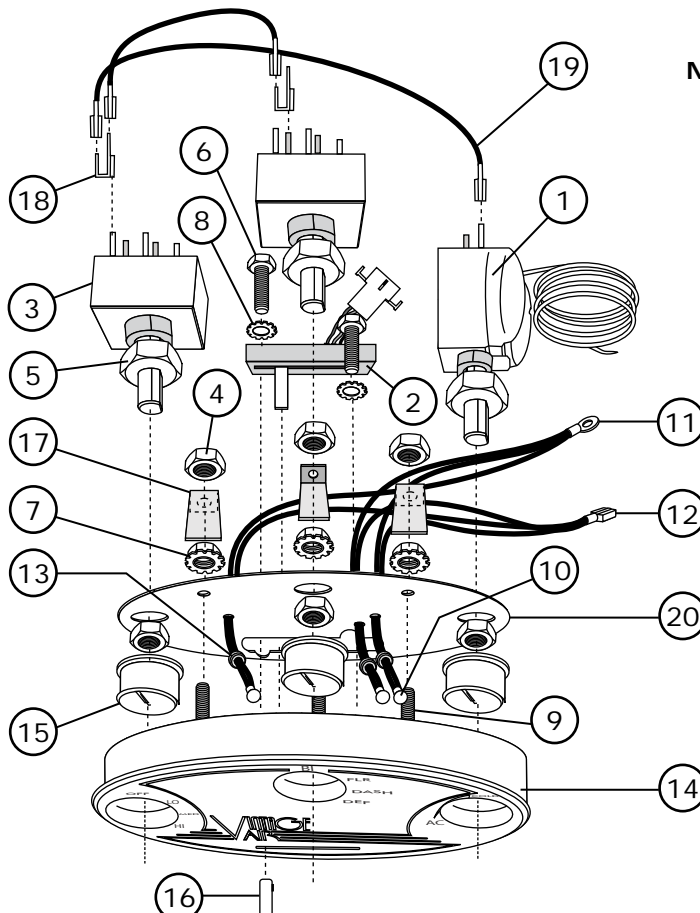

**NOTE: Images may not depict actual parts and quantities. Refer to packing list for actual parts and quantities.**





www.vintageair.com

## Streamline Control Panel Template

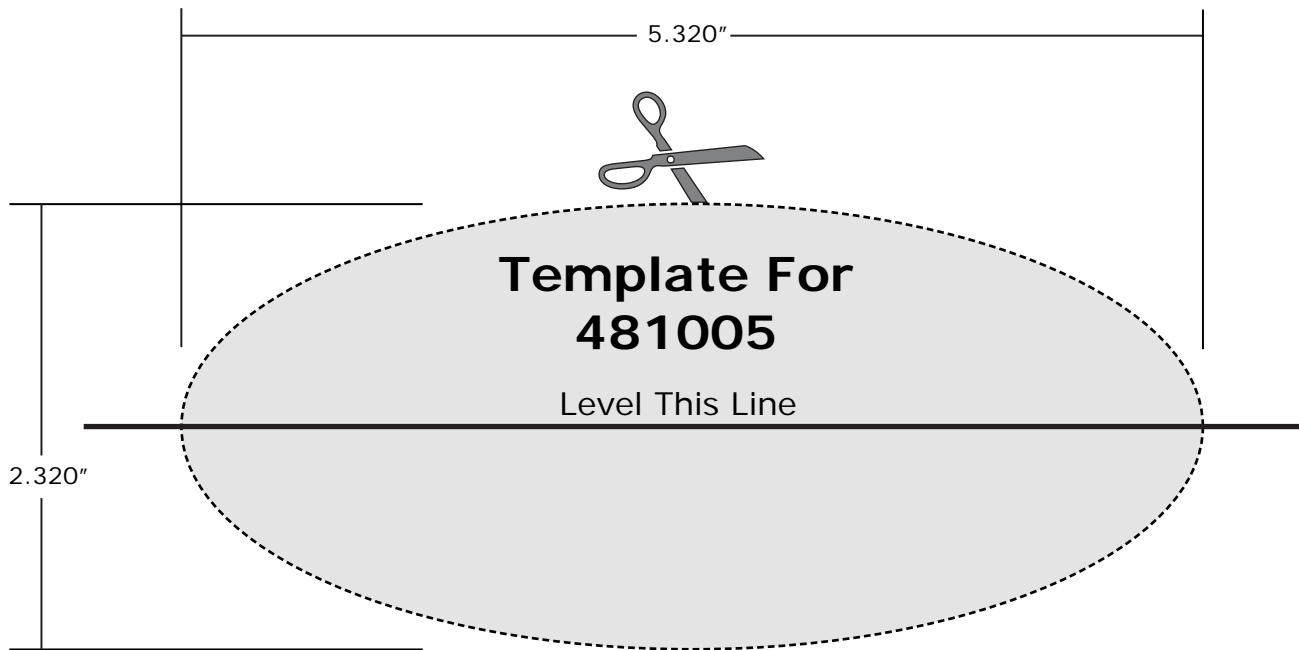

**NOTE:** Ensure that the template measures to dimensions noted above prior to cutting dash.

### Control Panel Installation

1. Select a suitable location for the control panel. Consider the heater control valve location, wiring harness length, and capillary tube to evaporator distance.
2. After selecting a location for the panel, mask the area 3 ½" (tall) x 5 ½" (wide).
3. Cut out the grey section of the template on the dotted line.
4. Mark the dash with a marker or scribe. **NOTE: Be sure to level the template on the dash.**
5. Cut out the opening for the panel.
6. Remove the backing plate from the face.
7. Install the face in the dash and reinstall the backing plate, making sure the wires for the lights exit the holes in the backing plate.
8. Install the nuts with star washers, and then the bracket and nyloc nuts. Do not overtighten the nyloc nuts.
9. Tie one wire from each light bulb together and run them to a ground.
10. Tie the other wires together and connect them to the wire in the vehicle's harness that powers the instrument panel lights (+12 volts).
11. For Gen II ComPac & Gen II Super units, wire according to the wiring diagram on Page 7. See Page 8 for the Gen II Mini.
12. Insert the capillary tube through the sticker on top of the evaporator, to the entire thickness of the coil.





www.vintageair.com

## Control Panel Installation (Cont.)

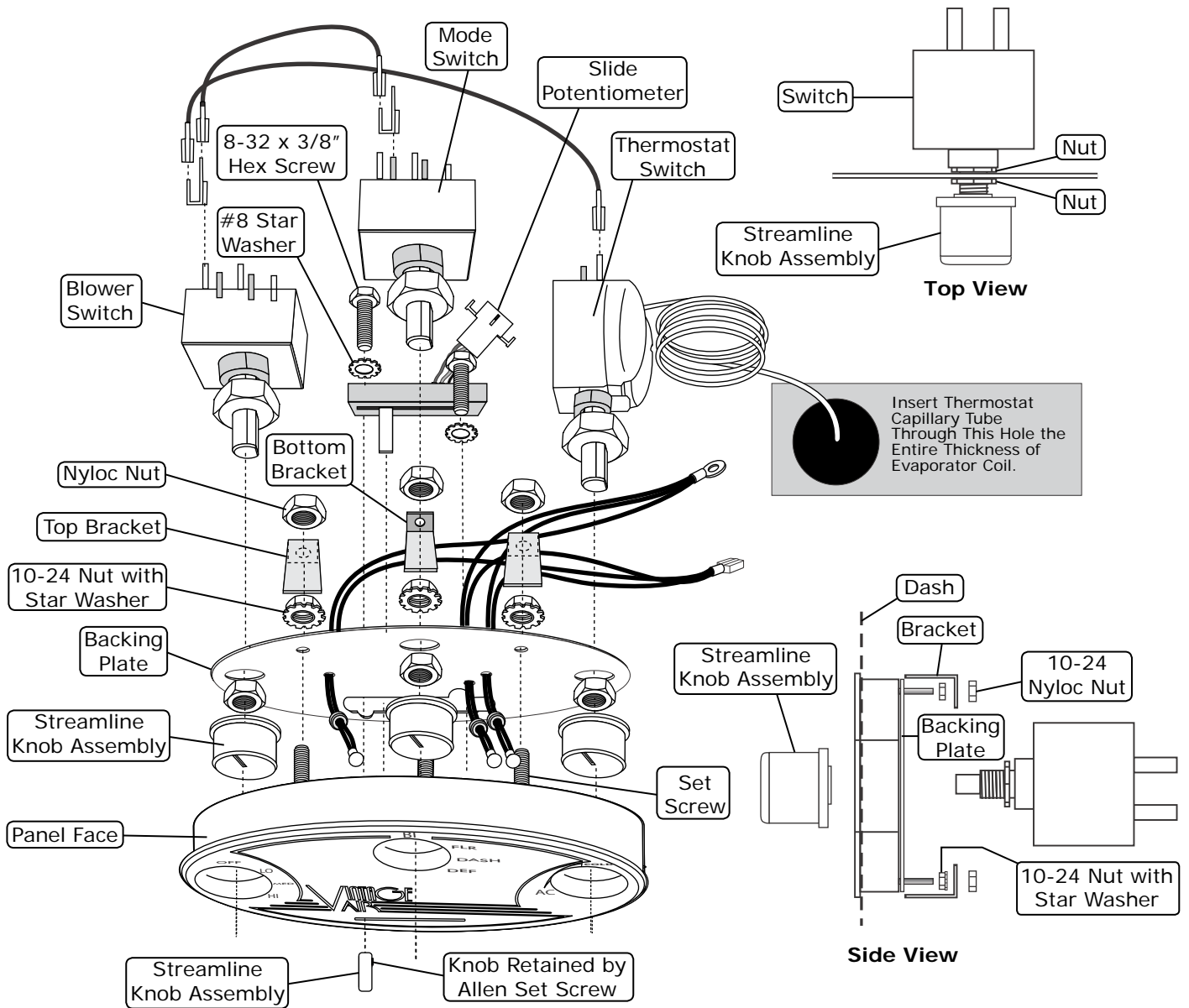

## Streamline Control Panel Wiring Diagram

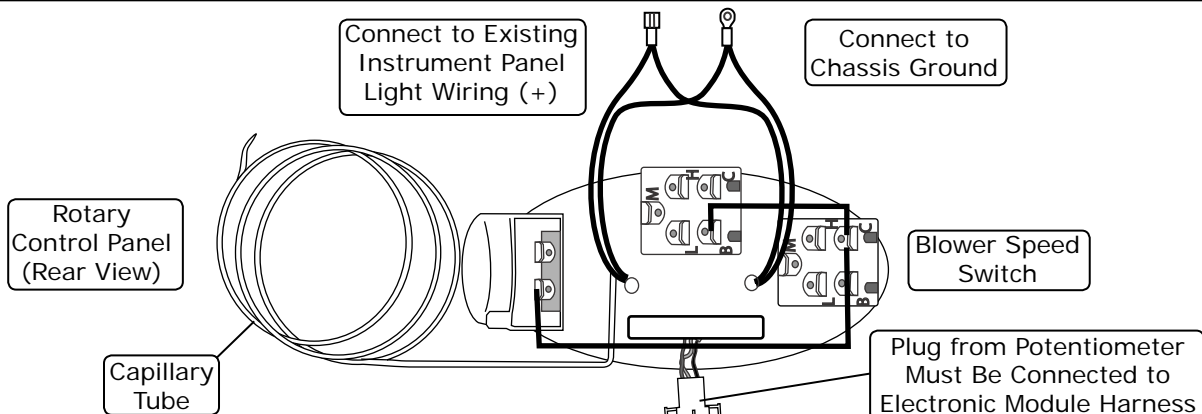



www.vintageair.com

## Streamline Operation of Controls

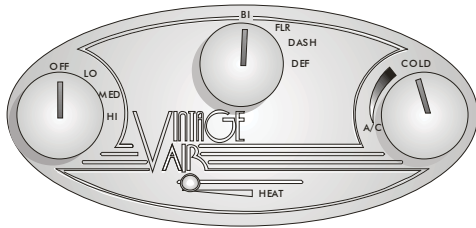

### System Off

Turning the blower speed knob to OFF will shut down the system in any mode.

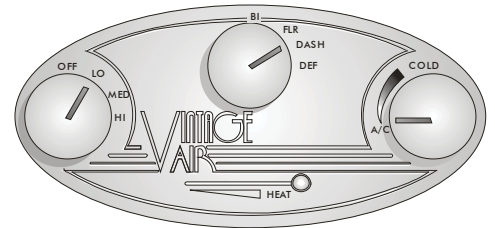

### Vent Heat Operation

Select blower speed. Rotate mode knob to DASH and slide the heater control lever to the right to open the hot water valve. Hot air will exit the dash vents.

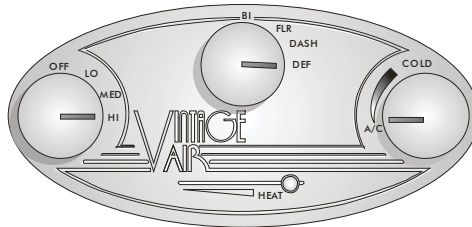

### Defrost Operation

#### (Optional, for Defrost Only!)

Select blower speed. Rotate mode knob to DEF. Turn the thermostat knob slightly clockwise to engage the compressor. Slide heater control lever to the right to open hot water valve to provide heated defrost air. Dehumidified defrost air will be directed to the windshield.

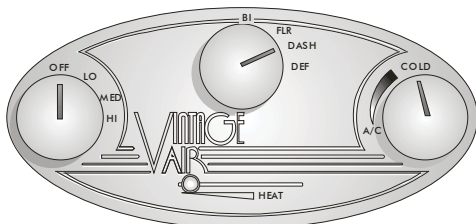

### A/C Operation

Select blower speed. Turn thermostat knob clockwise for cold air, and adjust mode knob to DASH or BI. Cold air will flow from vents. **NOTE: Duct temperature can be raised by slightly sliding the heater control lever to the right to open hot water valve. Hot water valve must be closed (full left) for coldest A/C setting.**

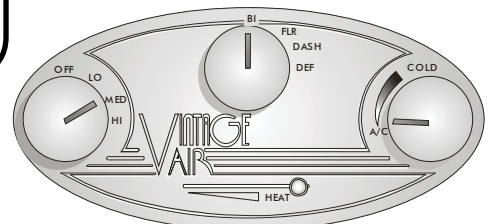

### Bi-Level Heat Operation

Select blower speed. Rotate mode knob to BI and slide the heater control lever to the right to open the hot water valve. Hot air will exit the dash and floor vents.

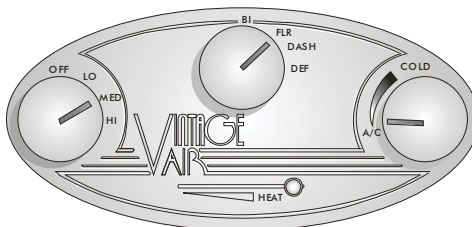

### Floor Heat Operation

Select blower speed. Rotate mode knob to FLR, and slide the heater control lever to the right to open the hot water valve. Hot air will exit the floor vents.





www.vintageair.com

# Wiring Diagram: Gen II ComPac/Super Units—Heat/Cool/Defrost

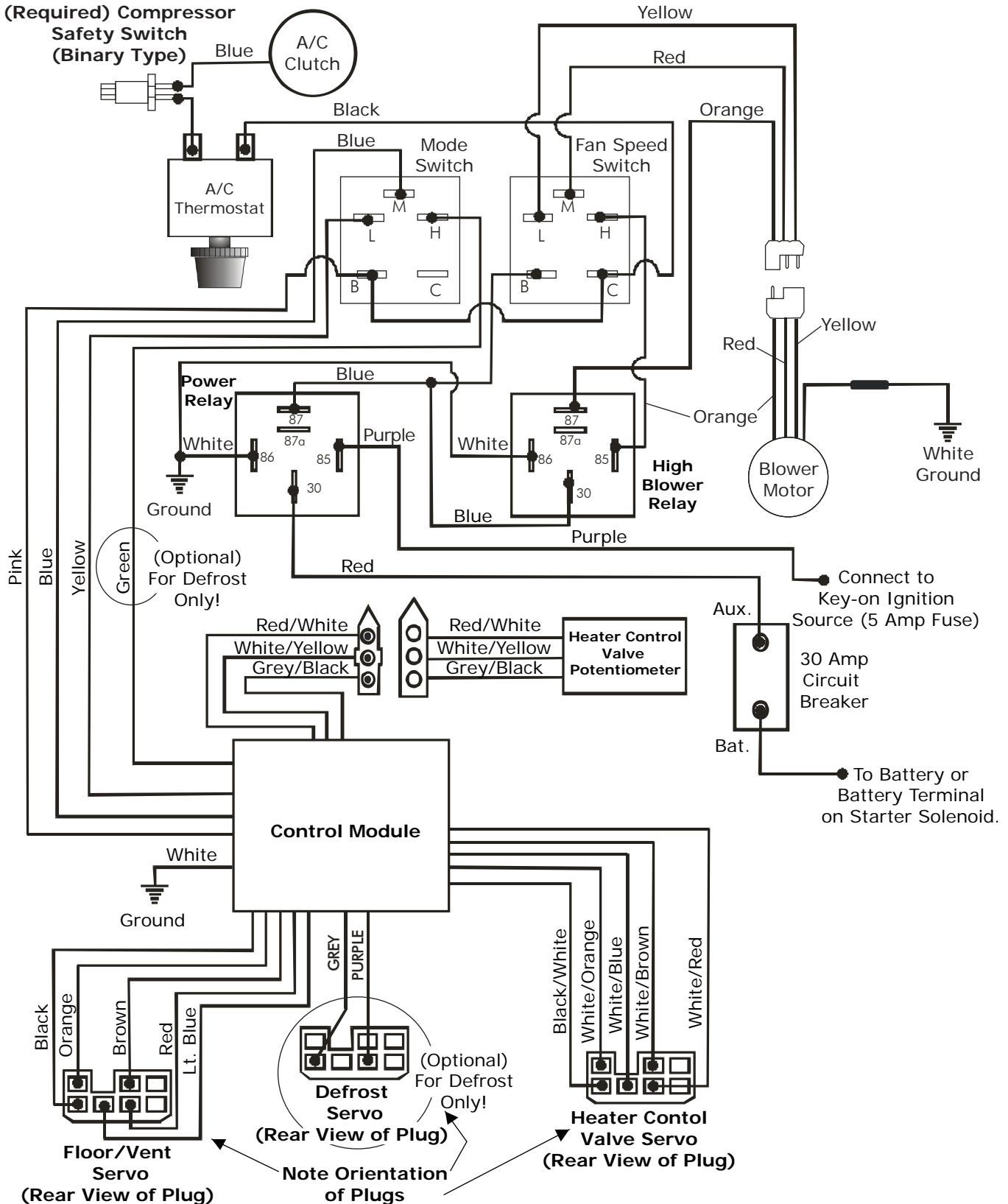



www.vintageair.com

# Wiring Diagram: Gen II Mini Units—Heat/Cool/Defrost

(Required) Compressor Safety Switch (Binary Type)

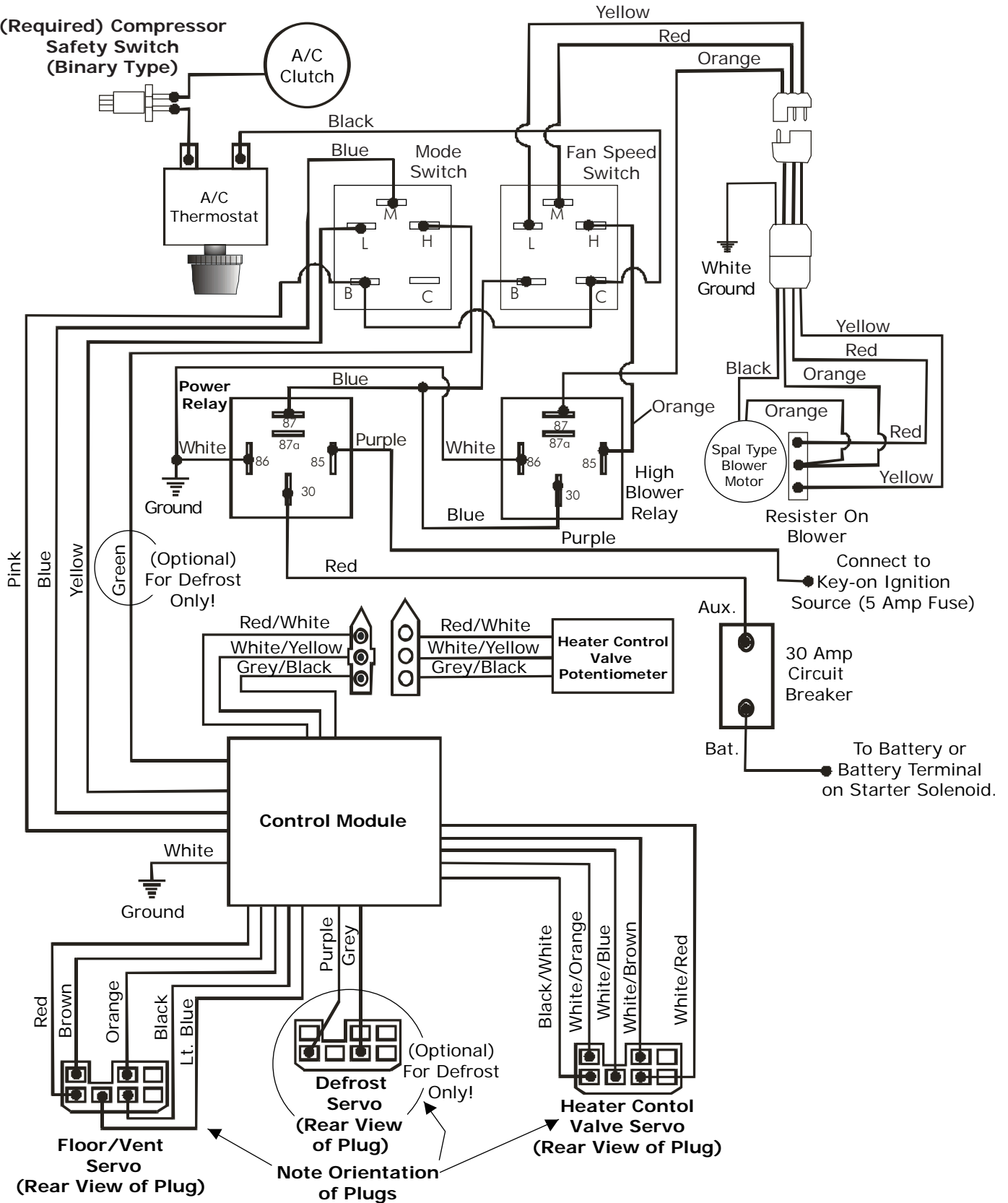



www.vintageair.com

## Important Notice—Please Read!

**NOTE:** Evaporator thermostat capillary tube must be inserted through evaporator sub case coil. See illustrations below. Refer to separate instructions included with your evaporator kit to insert the capillary tube.

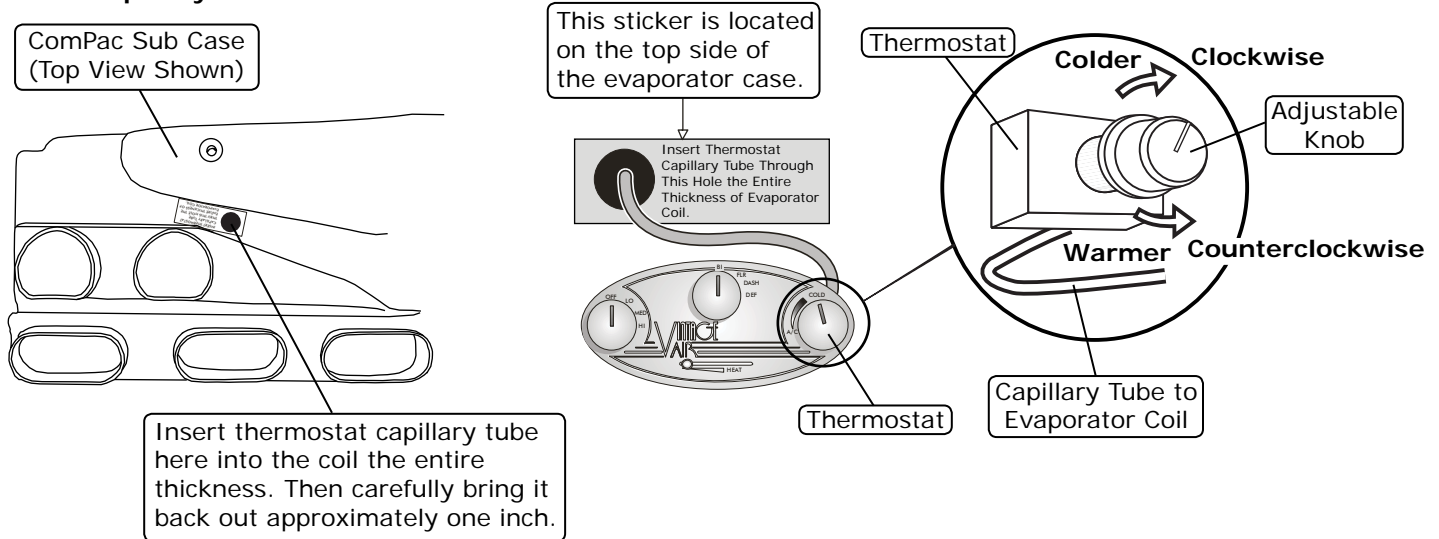

## Air Conditioning Adjustments

1. The air conditioner thermostat controls coil temperature. It is shipped adjusted fully cold (clockwise) and, in the majority of cases, the A/C will operate correctly as shipped.
2. Turning the knob on the thermostat to the right (clockwise) makes the system operate colder. If the thermostat is set too cold, the evaporator will ice up. If this happens, the evaporator coil is restricted with ice, and cold air flow will be reduced.
3. Turning the knob to the left (counterclockwise) makes the system operate warmer. The compressor clutch will cycle off frequently and the A/C system will not get as cool as it could.

## Adjusting A/C Thermostat

1. **Symptom:** The A/C works well at first, but then quits cooling. The air flow from the vents is low and the compressor cycles infrequently.  
**Solution:** The thermostat is set too cold and the evaporator is icing up and restricting air flow. Allow the ice to melt, and set the thermostat warmer (counterclockwise) 10% of a turn each adjustment until the symptoms diminish.
2. **Symptom:** A/C never gets cold and the compressor clutch cycles frequently.  
**Solution:** The thermostat is set too warm. Set the thermostat colder (clockwise) 10% of a turn each adjustment until the compressor clutch cycles infrequently. Avoid setting the thermostat too cold.
3. **Symptom:** The A/C never gets cold, sometimes even blows hot, and the A/C compressor clutch infrequently cycles off.  
**Solution:** The heater may be on at all times. Carefully feel around the heater hoses at the firewall. They should be cold when the A/C is on. If the hoses are hot:
  - A) The heater control valve may be installed backwards. Check the flow direction arrow on the valve against the illustration in your installation instructions.
  - B) The heater control valve is installed in the wrong heater hose.



www.vintageair.com

## Packing List: Control Panel Kit (481005)

No.	Qty.	Part No.	Description
1.	1	11092-VUT	Thermostat, 48", Adjustable Rotary
2.	1	11212-SUA	Slide Pot with Pigtail
3.	2	11458-VUS	Switch, 3-Speed Rotary
4.	3	18145-VUB	Nyloc Nut, 10-24
5.	6	18157-VUB	Shaft Nut, 7/16"
6.	2	18199-VUB	Screw, 8-32 x 3/8", Hex
7.	3	18260-VUB	Nut, 10-24 with Star Washer
8.	2	18262-VUB	Star Washer, #8
9.	3	18414-VUB	Set Screw, 10-24 x 3/4"
10.	3	20557-VUP	Light Bulb
11.	1	23120-VUW	Ring Terminal, #10 (22/18)
12.	1	23122-VUW	Spade Terminal, 1/4" (22/18)
13.	3	33138-VUI	Grommet, 1/4"
14.	1	492023	Panel Face, Streamline, Black
15.	3	492033	Knob Assembly, Streamline, Black Anodized
16.	1	492032	Slide Pot Knob, Streamline, Black
17.	3	64123-VUB	Bracket, Streamline Control Panel
18.	2	23123-VUW	Buddy Clip
19.	2	23139-VUW	Jumper Wire, 6"
20.	1	648178	Bracket, Rear Backing Plate

Checked By: \_\_\_\_\_  
Packed By: \_\_\_\_\_  
Date: \_\_\_\_\_

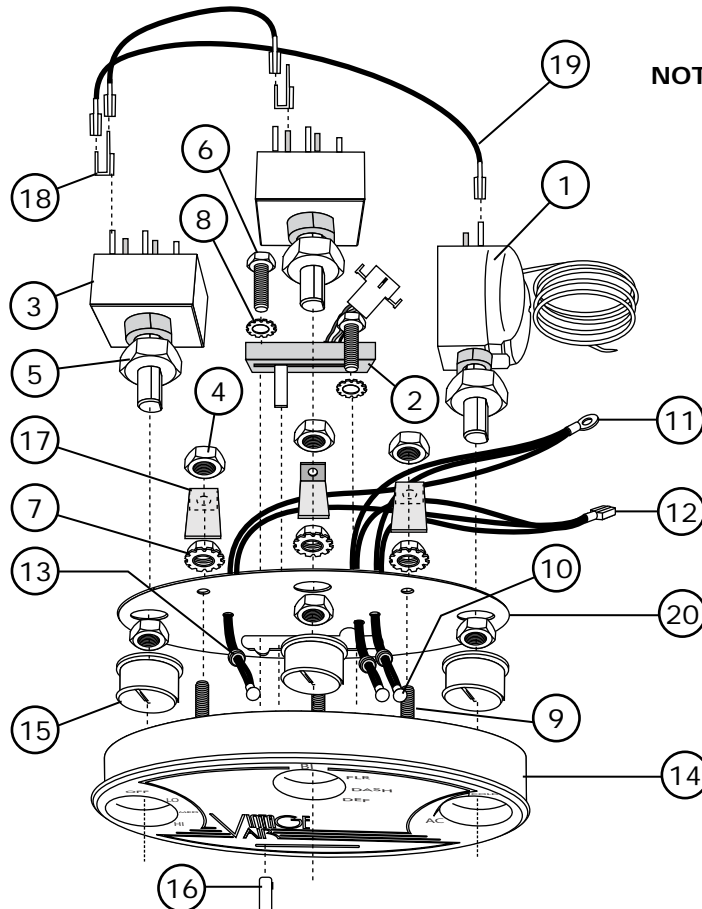

**NOTE: Images may not depict actual parts and quantities. Refer to packing list for actual parts and quantities.**