

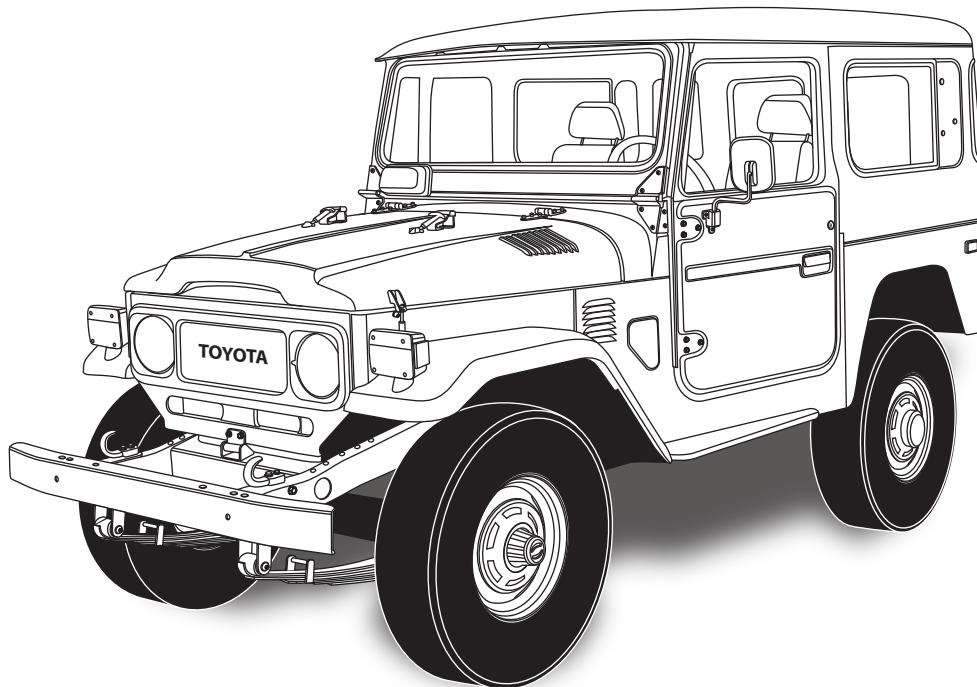

an ISO 9001:2008 Registered Company

# 1968-83 Toyota FJ40

Evaporator Kit  
(751200)



18865 Goll St. San Antonio, TX 78266

Phone: 800-862-6658

Sales: [sales@vintageair.com](mailto:sales@vintageair.com)

Tech Support: [tech@vintageair.com](mailto:tech@vintageair.com)

[www.vintageair.com](http://www.vintageair.com)



www.vintageair.com

# Table of Contents

Cover.....	1
Table of Contents.....	2
Packing List/Parts Disclaimer.....	3
Information Page.....	4
Wiring Notice.....	5
Control Panel Information, Louver Information.....	6
Additional Installation Information, Engine Compartment Disassembly, Condenser Assembly and Installation, Compressor and Brackets.....	7
Passenger Compartment Disassembly.....	8
Engine Compartment Disassembly (Cont.).....	9
Firewall Modification.....	10
Firewall Modification (Cont.).....	11
Control Panel Installation.....	12
Control Panel Installation (Cont.).....	13
Control Panel Installation (Final).....	14
Evaporator Pre-Installation.....	15
Evaporator Pre-Installation (Cont.).....	16
Evaporator Pre-Installation (Cont.).....	17
Evaporator Pre-Installation (Cont.).....	18
Evaporator Pre-Installation (Cont.), Defrost Duct Hose Installation.....	19
Wiring Installation.....	20
Wiring Installation (Cont.).....	21
Evaporator Installation.....	22
Evaporator Installation (Cont.).....	23
Drain Hose Installation.....	24
Engine Compartment Hose and Wiring Connections.....	25
Engine Compartment Hose and Wiring Connections (Cont.).....	26
Lubricating O-rings, A/C Hose Installation.....	27
A/C and Heater Hose Routing.....	28
ECU & ECU Bracket Installation.....	29
ECU & ECU Bracket Installation (Cont.), Dash Pad Filler Installation.....	30
Louver Bezel Support Bracket Installation, Final Steps.....	31
Evaporator Under Dash Cover Installation (Optional).....	32
Wiring Diagram.....	33
Gen IV Wiring Connection Instruction.....	34
Operation of Controls.....	35
Troubleshooting Guide.....	36
Troubleshooting Guide (Cont.).....	37
Packing List.....	38



www.vintageair.com

## Packing List: Evaporator Kit (751200)

No.	Qty.	Part No.	Description
1.	1	744016	Gen IV Evaporator Sub Case
2.	1	791200	Accessory Kit

**\*\* Before beginning installation, open all packages and check contents of shipment. Please report any shortages directly to Vintage Air within 15 days. After 15 days, Vintage Air will not be responsible for missing or damaged items.**

1

Gen IV Evaporator  
Sub Case  
744016

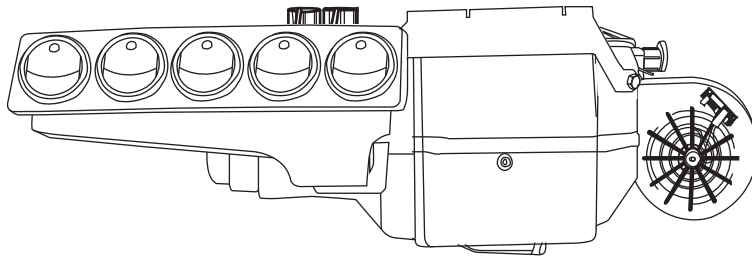

2

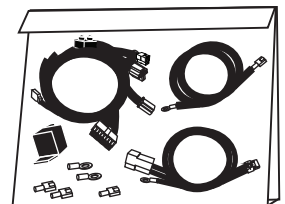
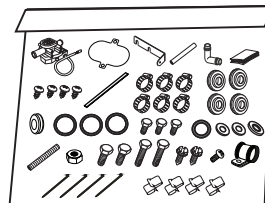
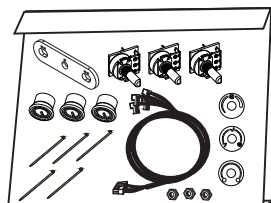
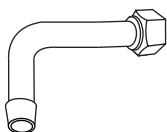
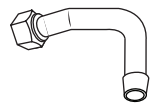
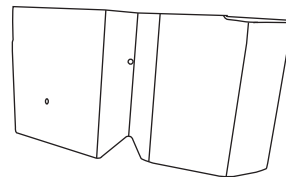
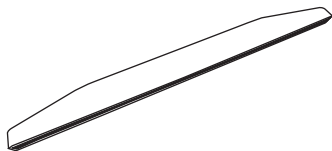
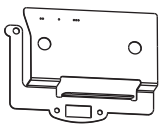
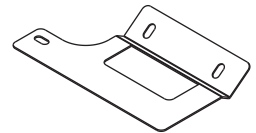
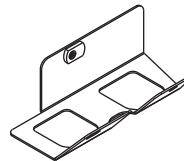
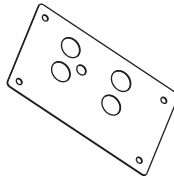
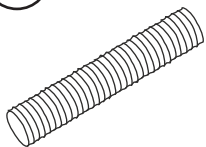

Accessory Kit  
791200

**NOTE: Images may not depict actual parts and quantities. Refer to packing list for actual parts and quantities.**



www.vintageair.com

## Important Notice—Please Read

*For Maximum System Performance, Vintage Air Recommends the Following:*

**NOTE:** Vintage Air systems are designed to operate with R134a refrigerant only. Use of any other refrigerant could damage your A/C system and/or vehicle, and possibly cause a fire, in addition to potentially voiding the warranties of the A/C system and its components.

### Refrigerant Capacities:

**Vintage Air System:** 1.8 lbs. (1 lb., 12 oz.) of **R134a**, charged by weight with a quality charging station or scale. **NOTE: Use of the proper type and amount of refrigerant is critical to system operation and performance.**

**Other Systems:** Consult manufacturer's guidelines.

### Lubricant Capacities:

**New Vintage Air-supplied Sanden Compressor:** No additional oil needed (Compressor is shipped with proper oil charge).

**All Other Compressors:** Consult manufacturer (Some compressors are shipped dry and will need oil added).

### Safety Switches

Your Vintage Air system is equipped with a binary pressure safety switch. A binary switch disengages the compressor clutch in cases of extreme low pressure conditions (Refrigerant Loss) or excessively high head pressure (406 PSI) to prevent compressor damage or hose rupture. A trinary switch combines Hi/Lo pressure protection with an electric fan operation signal at 254 PSI, and should be substituted for use with electric fans. Compressor safety switches are extremely important since an A/C system relies on refrigerant to circulate lubricant.

### Service Info:

**Protect Your Investment:** Prior to assembly, it is critical that the compressor, evaporator, A/C hoses and fittings, hardlines, condenser and receiver/drier remained capped. Removing caps prior to assembly will allow moisture, insects and debris into the components, possibly leading to reduced performance and/or premature failure of your A/C system. This is especially important with the receiver/drier.

Additionally, when caps are removed for assembly, **BE CAREFUL!** Some components are shipped under pressure with dry nitrogen.

**Evacuate the System for 35-45 Minutes:** Ensure that system components (Drier, compressor, evaporator and condenser) are at a temperature of at least 85° F. On a cool day, the components can be heated with a heat gun **or** by running the engine with the heater on before evacuating. Leak check and charge to specifications.

### Bolts Passing Through Cowl and/or Firewall:

To ensure a watertight seal between the passenger compartment and the vehicle exterior, for all bolts passing through the cowl and/or firewall, Vintage Air recommends coating the threads with silicone prior to installation.

### Heater Hose (Not Included With This Kit):

Heater hose may be purchased from Vintage Air (Part# 31800-VUD) or your local parts retailer. Routing and required length will vary based on installer preference.





www.vintageair.com

## Important Wiring Notice—Please Read

*Some Vehicles May Have Had Some or All of Their Radio Interference Capacitors Removed. There Should Be a Capacitor Found At Each of the Following Locations:*

- 1. On the positive terminal of the ignition coil.**
- 2. If there is a generator, on the armature terminal of the generator.**
- 3. If there is a generator, on the battery terminal of the voltage regulator.**

Most alternators have a capacitor installed internally to eliminate what is called “whining” as the engine is revved. If whining is heard in the radio, or just to be extra cautious, a radio interference capacitor can be added to the battery terminal of the alternator.

It is also important that the battery lead is in good shape and that the ground leads are not compromised. There should be a heavy ground from the battery to the engine block, and additional grounds to the body and chassis.

If these precautions are not observed, it is possible for voltage spikes to be present on the battery leads. These spikes come from ignition systems, charging systems, and from switching some of the vehicle’s other systems on and off. Modern computer-operated equipment can be sensitive to voltage spikes on the power leads, which can cause unexpected resets, strange behavior, and/or permanent damage.

Vintage Air strives to harden our products against these types of electrical noise, but there is a point where a vehicle’s electrical system can be degraded so much that nothing can help.

Radio interference capacitors should be available at most auto and truck parts suppliers. They typically are cylindrical in shape, a little over an inch long, a little over a half inch in diameter, and they have a single lead coming from one end of the cylinder with a terminal on the end of the wire, as well as a mounting clip which is screwed into a good ground on the vehicle. The specific value of the capacitance is not too significant in comparison to ignition capacitors that are matched with the coil to reduce pitting of the points.

- Care must be taken, when installing the compressor lead, not to short it to ground. The compressor lead must not be connected to a condenser fan or to any other auxiliary device. Shorting to ground or connecting to a condenser fan or any other auxiliary device may damage wiring, the compressor relay, and/or cause a malfunction.
- When installing ground leads on Gen IV systems, the blower control ground and ECU ground must be connected directly to the negative battery post.
- For proper system operation, the heater control valve must be connected to the ECU.



www.vintageair.com

## Control Panel Information—Please Read

The supplied control panel kit is shown below, and includes (3) black rubber knobs with labels. For a more customized look, (2) additional options are available for purchase from Vintage Air.

### A. Control Panel Knob Upgrade Kit (471201):

This kit features (3) aluminum knobs and decal bezels with labels as shown below. **NOTE: On some FJ40 models, the control panel dash holes are tightly spaced, and the outer holes on each side may need to be enlarged or slotted outward to accommodate the decal bezels supplied with this kit.**

### B. Black Anodized Streamline Control Panel (491223-RUA):

This control panel can be mounted in the dash for a built-in look as shown below.

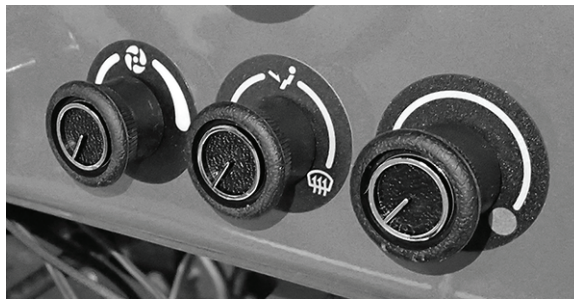

Included



Option A

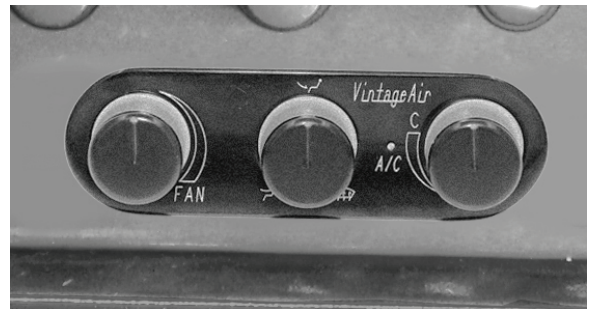

Option B

## Louver Information—Please Read

This kit contains (5) 2 ½" black plastic louvers. For a more customized look, a wide selection of 2 ½" louvers is available for purchase from Vintage Air.



www.vintageair.com

## Additional Installation Information—Please Read

As Vintage Air strives to remain on the cutting edge of technology and innovation, we are proud to introduce our new 1968-83 Toyota FJ40 SureFit™ kit, featuring state-of-the-art Gen IV technology and electronic controls.

To ensure a watertight seal between the passenger compartment and the vehicle exterior, for all bolts passing through the firewall, Vintage Air recommends coating the threads with silicone prior to installation.

**NOTE: Toyota produced many variations of the FJ40, depending on market location. This kit and all accompanying instructions are designed specifically for 1968-83 FJ40 models built for the US market. While our FJ40 kits have been successfully installed in early and non-US FJ40s, our technicians do not have specific information, procedures or photos for such installations. While our tech department will always assist as much as possible, knowledge regarding the specifications of an individual vehicle is the customer's responsibility.**

### *Engine Compartment Disassembly*

**NOTE: Before starting the installation, check the function of the vehicle (horn, lights, etc.) for proper operation, and study the instructions, illustrations, & diagrams. Retain OEM bolts, washers and nuts (unless otherwise indicated), as some hardware will be reused.**

**Perform the Following:**

1. Disconnect the battery.
2. Remove the battery (retain).
3. Drain the radiator.

### *Condenser Assembly and Installation*

1. Refer to separate instructions included with the condenser kit to install the condenser.
2. Binary switch installation (Refer to condenser instructions).

### *Compressor and Brackets*

1. Refer to separate instructions included with the bracket kit to install the compressor bracket.



www.vintageair.com

## Passenger Compartment Disassembly

### Perform the Following:

1. Remove the plastic heater duct by removing (2) bolts from the firewall (See Photo 1, below).
2. Disconnect the duct hoses from the (2) defrost ducts (See Photo 2, below). Remove the ducts along with the plastic diverters (See Photo 3, below).
3. Disconnect the heater hoses from the heater assembly by removing the clamps and covers (See Photo 3, below). **NOTE: Use a rag to collect any leftover antifreeze that may spill.**
4. Remove the heater assembly by removing (4) bolts from the firewall, (2) on the driver side and (2) on the passenger side (See Photo 4, below).
5. After removing the heater assembly, reinstall the (2) driver side bolts into the firewall. These bolts will not be reused. **NOTE: Discard the top passenger side bolt. Use silicone or seam sealer to cover the firewall weld nut. The bottom passenger side bolt will be reused to install the evaporator front driver side bracket to the firewall (See Photo 5, below).**
6. Remove the AC outlet from the inner left wall of the glove box by removing (2) screws (discard) and disconnecting the wires on the back. **NOTE: Be sure to keep the outlet wires inside the glove box, as it will be difficult to bring them in once the evaporator is installed. This outlet will be reinstalled together with the ECU bracket on Page 29 (See Photo 6, below).**

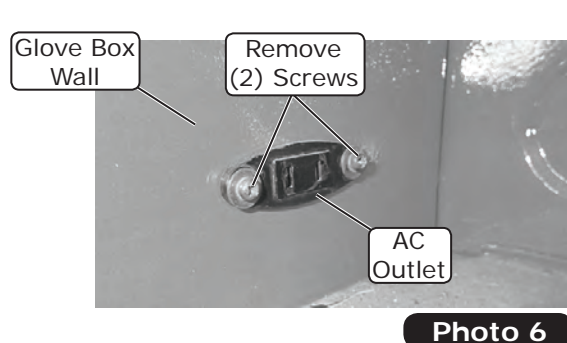
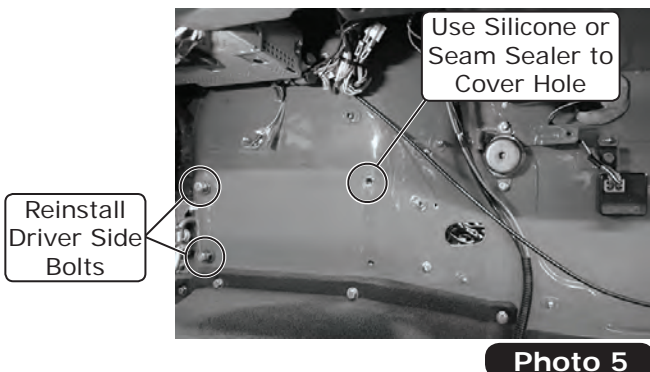
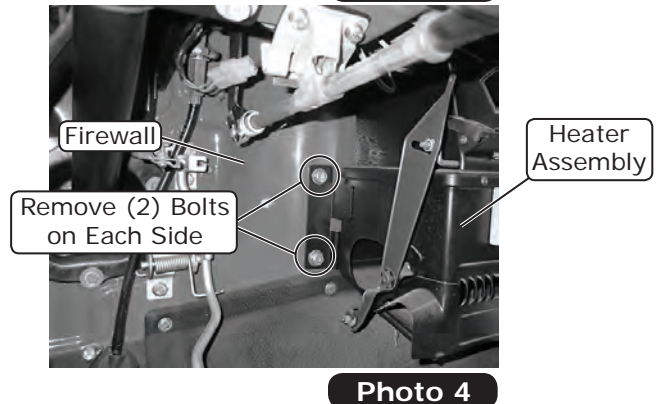
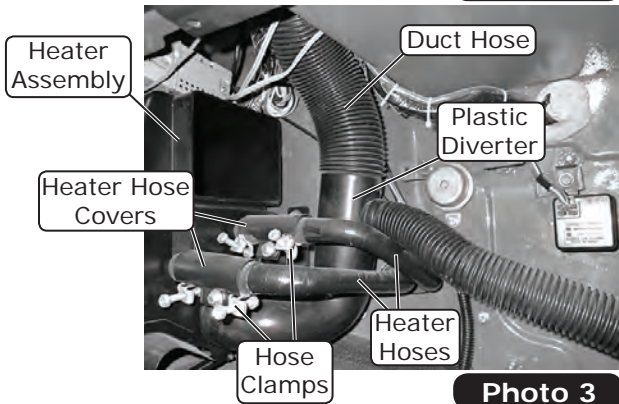
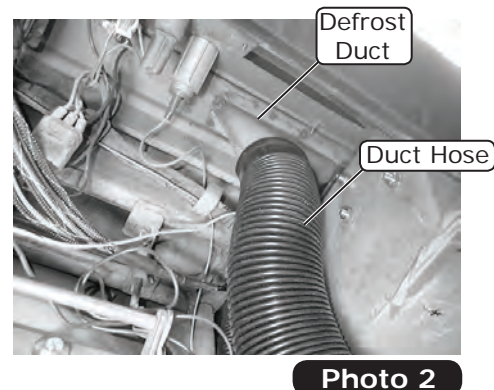
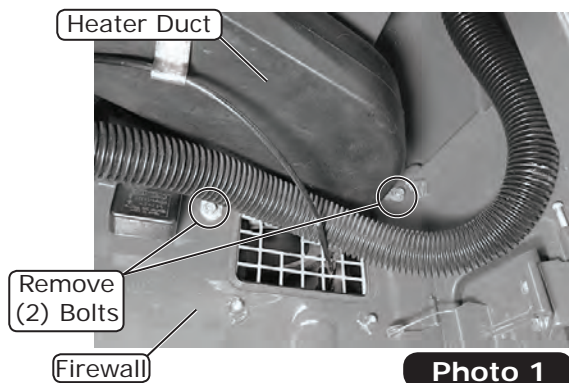





www.vintageair.com

## Engine Compartment Disassembly (Cont. from Page 7)

4. Remove the screw retaining the heater valve cable and cable clamp. Remove the cable clamp, and slide the cable out of the clamp. Remove the (2) heater hoses and the rubber grommet from the firewall. Remove the heater valve by removing the (2) bolts securing it to the firewall (See Photo 7, below). **NOTE: After removing the heater valve, reinstall the (2) bolts into the firewall to seal the unused holes.**
5. Perform the following to open the blower assembly and remove the fresh air cable:
  - A. Disconnect the (3) wires attached to the blower assembly (See Photo 8, below).
  - B. Remove the (3) screws holding the blower onto the assembly. Remove the (5) screws around the blower assembly and the (2) bolts securing the assembly to the firewall (See Photo 8, below). Remove the top of the blower assembly.
  - C. Remove the plate from the blower assembly (See Photo 9, below). Remove the fresh air door from the blower assembly housing, and disconnect the fresh air cable (See Photo 10, below).
  - D. Remove the bottom side of the blower assembly by removing (2) bolts securing it to the firewall (See Photo 11, below). **NOTE: Retain the (4) OEM bolts used to secure the blower assembly to the firewall. The bolts will be reused to install the firewall cover plate.**

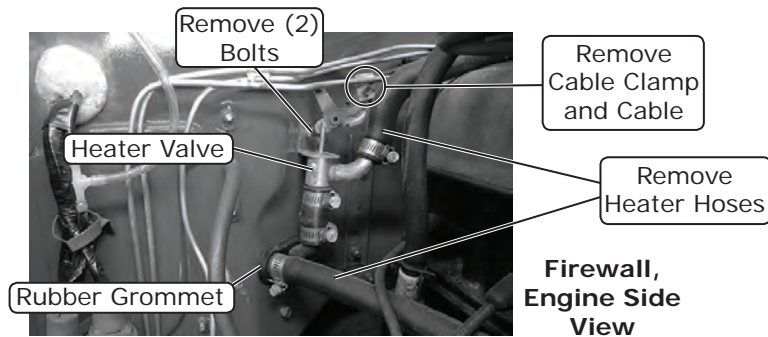

Photo 7

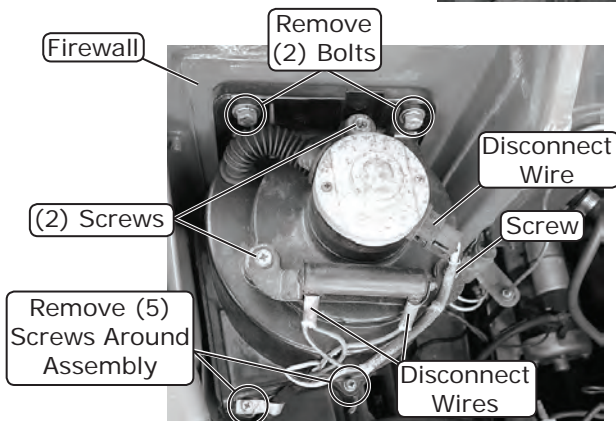

Photo 8

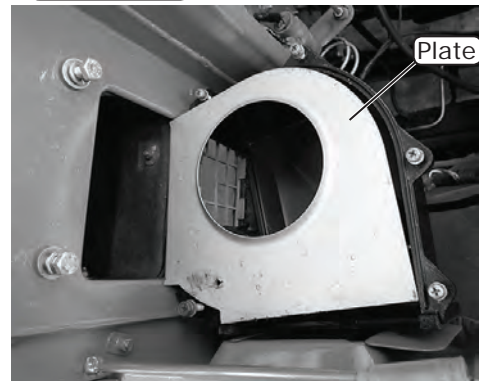

Photo 9

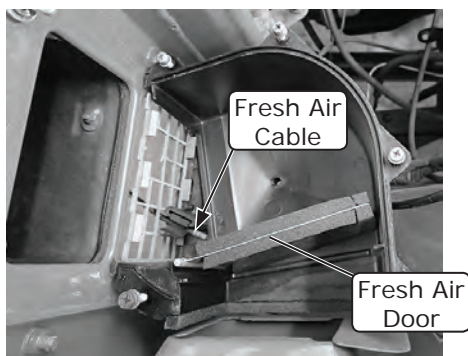

Photo 10

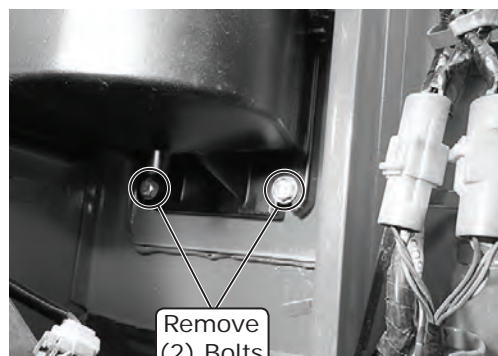

Photo 11



www.vintageair.com

## Firewall Modification

**NOTE:** The evaporator unit will be installed against the firewall. Any obstruction will make the installation more difficult. Some FJ40 models have switches, relays or other devices mounted on the passenger compartment side of the firewall that will need to be relocated. The mounting brackets will need to be bent or trimmed. After evaporator installation, the space between the firewall and the front of the evaporator is approximately 1". Wires mounted on the firewall can remain in place.

1. Remove any relays or devices mounted on the passenger compartment side of the firewall. Bend or trim the mounting brackets, and relocate them to another area (See Photo 12, below). **NOTE: Relocating the relays to the outer left side of the glove box is recommended.**
2. On FJ40 models with the 2F engine, there is a distributor vent filter mounted on the passenger compartment side of the firewall (See Photo 12, below). The distributor vent filter will need to be relocated to the engine side of the firewall, and sealed to prevent moisture from entering the filter. To relocate, perform the following:
  - A. In the passenger compartment, remove the distributor vent filter from the firewall by removing (2) bolts (discard bolts) (See Photo 12, below). Disconnect the hose.
  - B. Apply a bead of silicone onto the filter surface, leaving the center hole clear. **NOTE: Be sure the silicone will not enter the hole when reinstalling the distributor vent filter. The hole must remain open and clear (See Photo 13, below).**
  - C. On the engine side of the firewall, reinstall the distributor vent filter in the same location on the firewall using (2) M6 x 1 x 30mm hex bolts. Reinstall the hose onto the filter (See Photo 14, below).

Firewall,  
Passenger  
Compartment  
View

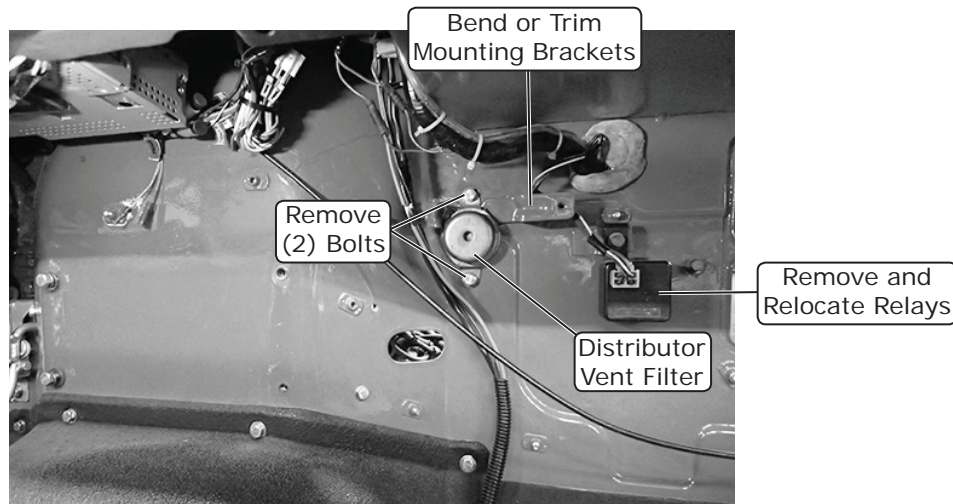

Photo 12

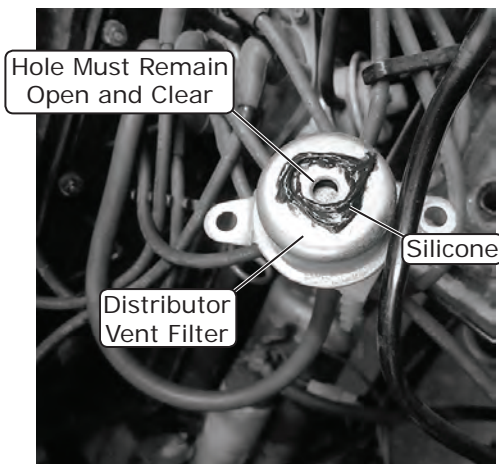

Photo 13

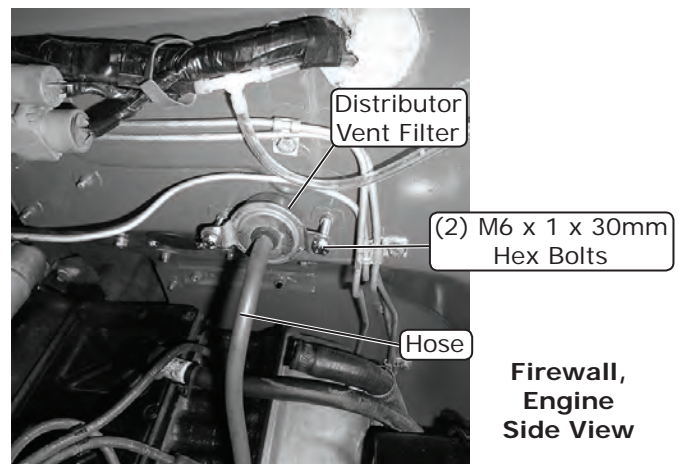

Photo 14

Firewall,  
Engine  
Side View





www.vintageair.com

## Firewall Modification (Cont.)

3. In the passenger compartment, place and center the heater hose delete plate over the heater hose opening on the firewall (See Photos 15 and 16, below). Mark the top and bottom bracket holes onto the firewall. Remove the bracket, and drill (2) 5/32" holes through the firewall (See Photo 16, below).
4. From the engine compartment, install the delete plate onto the firewall, and secure it using (2) #10 x 1/2" sheet metal screws. Seal the seam around the delete plate using silicone or seam sealer (See Photo 17, below).
5. From the engine compartment, locate the weld nut on the right side of the blower assembly opening on the firewall (See Photo 18, below). Enlarge the hole using a 3/8" drill bit (See Photo 19, below). **NOTE: The weld nut will be removed when enlarging the hole. The hole will be used to install the evaporator front passenger side bracket.**

Firewall,  
Passenger  
Compartment  
View

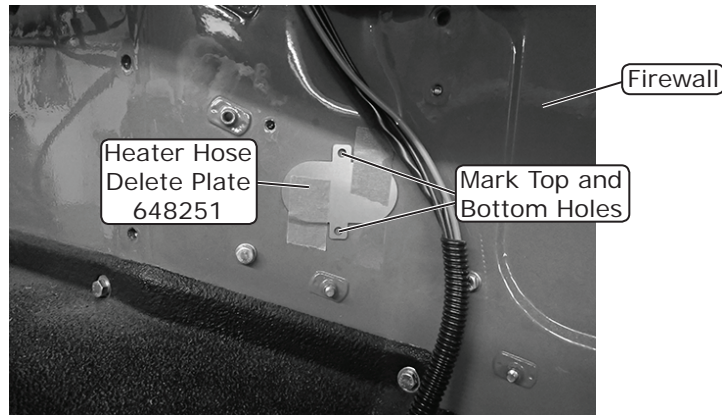

Photo 15

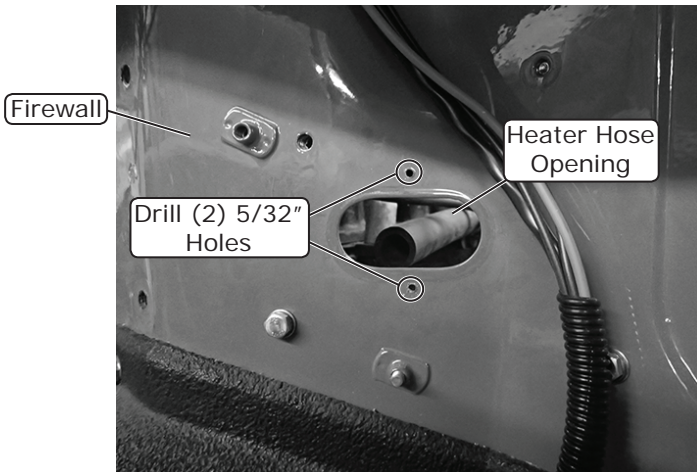
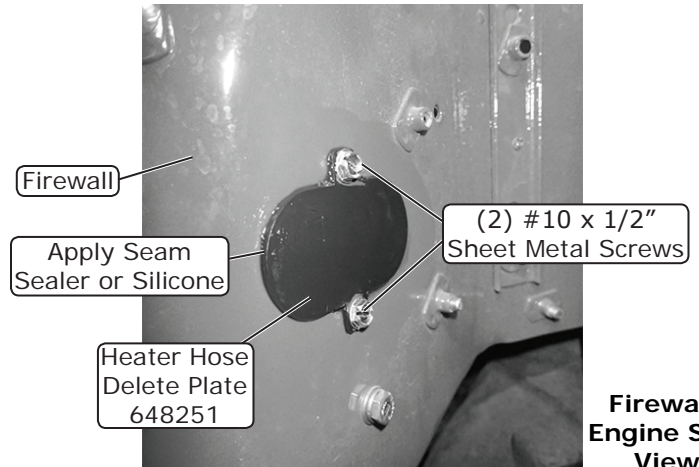

Photo 16



Firewall,  
Engine Side  
View

Photo 17



Firewall,  
Engine  
Side  
View

Photo 18



Photo 19





www.vintageair.com

## Control Panel Installation

**NOTE:** To remove the (3) OEM pull knobs and install the new rotary controls, Vintage Air recommends temporarily removing the radio (if equipped) for an easier installation. This kit was designed around the OEM radio. Aftermarket radios may require repositioning.

1. Remove the Fan, Fresh Air and Warm pull knobs (See Photo 20, below). **NOTE:** For early FJ40 models, disconnect the cables from behind the dash. Remove the knob by removing the set screw on the side. Unscrew the knob and bezel from the front (See Photo 21, below). For later FJ40 models, disconnect the cables and remove the nuts from behind the dash (See Photos 22 & 23, below).
2. To accommodate the rotary controls and hardware, the OEM dash holes will need to be modified. **NOTE:** Vintage Air recommends using a file to modify the holes (See Photos 24 & 25, below).
  - A. Enlarge the 1st hole to 3/8". **NOTE:** Do not enlarge the hole to more than 3/8".
  - B. Round the 2nd and 3rd holes without enlarging them.

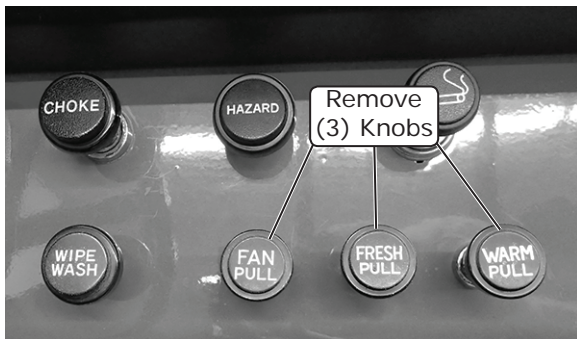

Photo 20

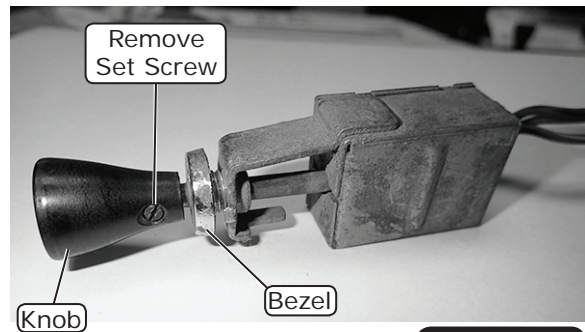

Photo 21



Photo 22

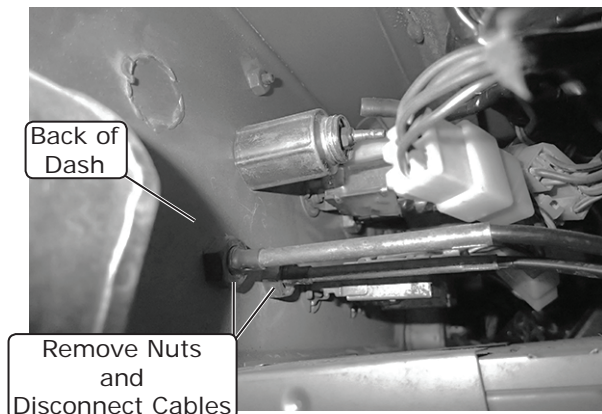
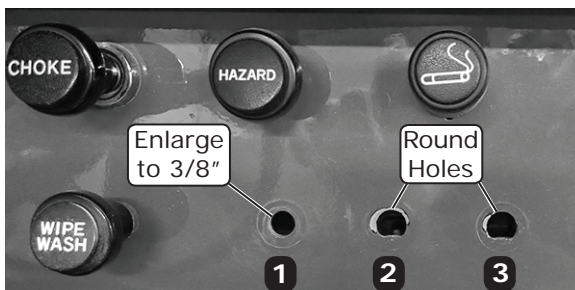
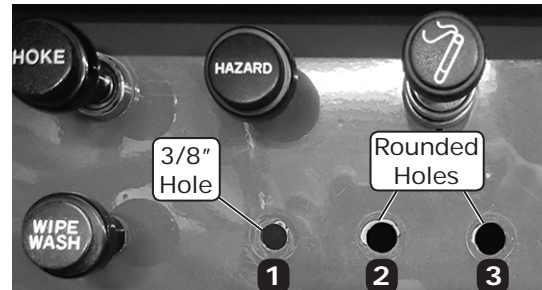

Photo 23



Before Enlargement and Rounding

Photo 24



After Enlargement and Rounding

Photo 25



www.vintageair.com

## Control Panel Installation (Cont.)

3. Install the control labels onto the dash as shown in Photo 26, below. **NOTE: Make sure the dash surface is clean and free of debris before installing the labels.**
4. Locate the (3) rotary pot assemblies, and remove a washer and nut from each one (discard) (See Photo 27, below).
5. Install the wiring harness onto the rotary pots as shown in Figure 1, below.
6. Secure the wiring to the rotary pots using the tie wraps provided (See Figure 1, below).

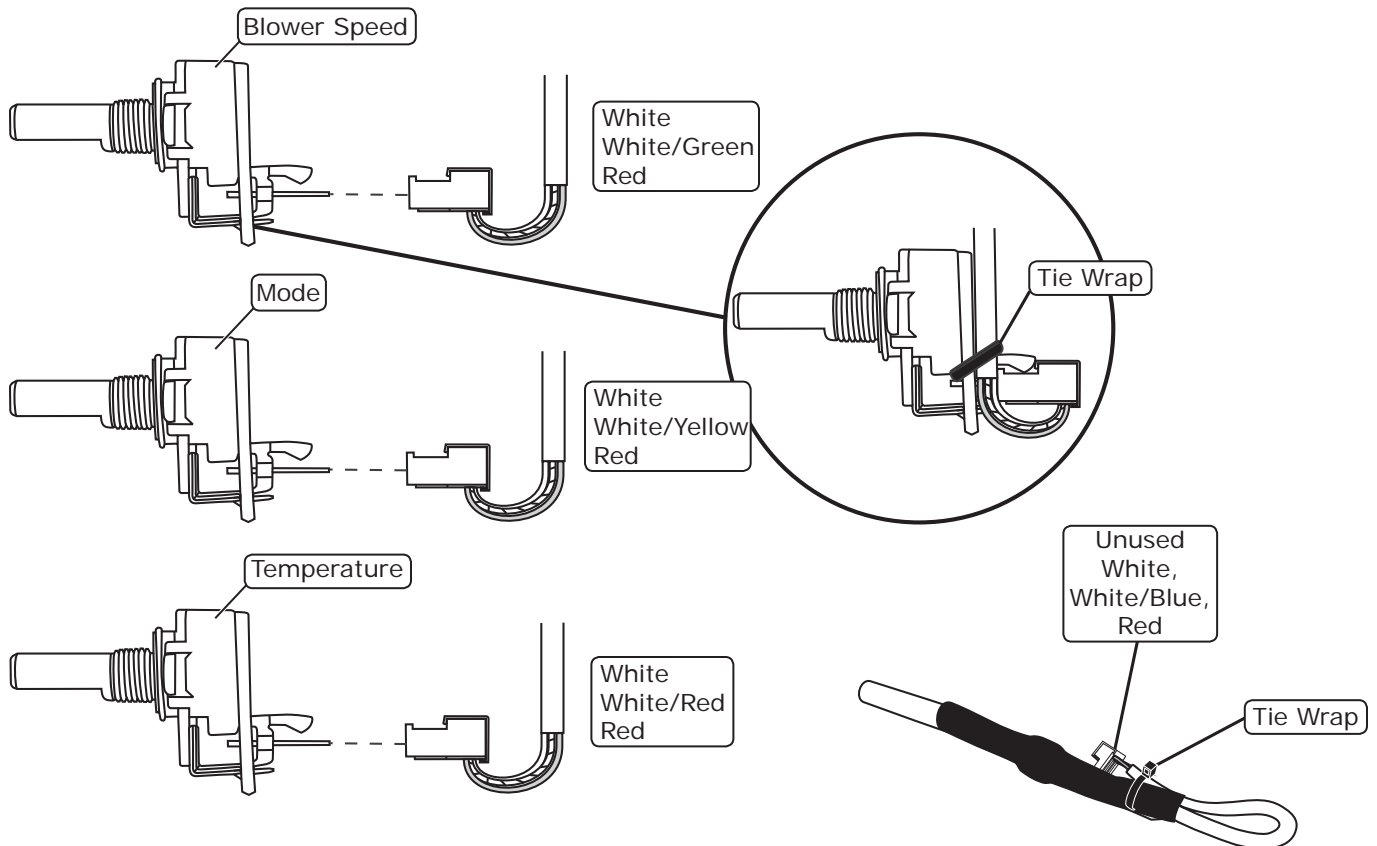
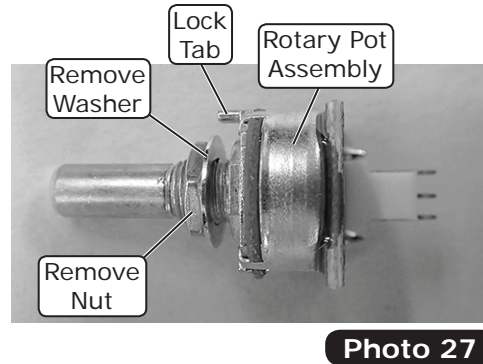
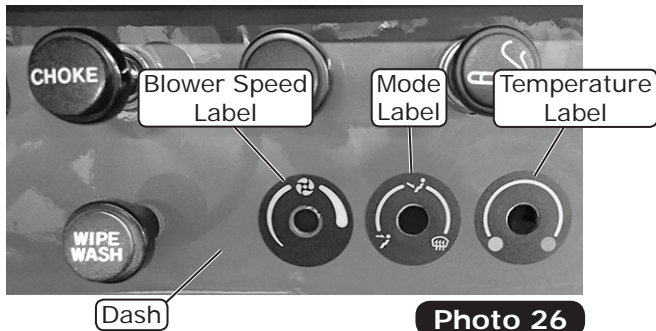

**NOTE: Tie the unused wire to the wiring harness as shown above.**



www.vintageair.com

## Control Panel Installation (Final)

7. Insert the (3) rotary pots into the dash control bracket holes in the order shown in Photo 28, below. Be sure the lock tab on each rotary pot is seated in the appropriate notch on the bracket (See Photo 27, Page 13, and Photo 28, below). **NOTE: The outer dash control bracket holes are slotted to account for variances among dash hole locations by allowing (2) different mounting positions for the outer controls. Measure the distance between the centers of the outer dash holes to determine the appropriate dash control bracket mounting position (See Photo 28, below).**
8. While holding the (3) rotary pots in position, place the dash control bracket behind the dash, and insert the rotary pots into the (3) OEM holes on the dash. From the front, install a rotary pot nut onto each rotary pot to secure the control panel assembly as shown in Figure 2, below. **NOTE: Be sure each rotary pot is seated correctly with the lock tab inside the appropriate notch on the bracket. Level and center the controls, and tighten all (3) rotary pot nuts (See Photo 29, below).**
9. Install the (3) rotary control knobs by pushing them onto the rotary pot shafts (See Photos 29 & 30, below).
10. Route the 12-pin control panel harness over the left side of the glove box. **NOTE: Be sure to secure the harness to the glove box, or it will fall behind the dash, making it extremely difficult to retrieve.**

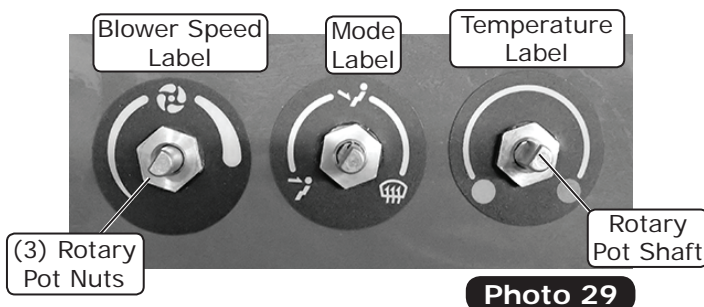
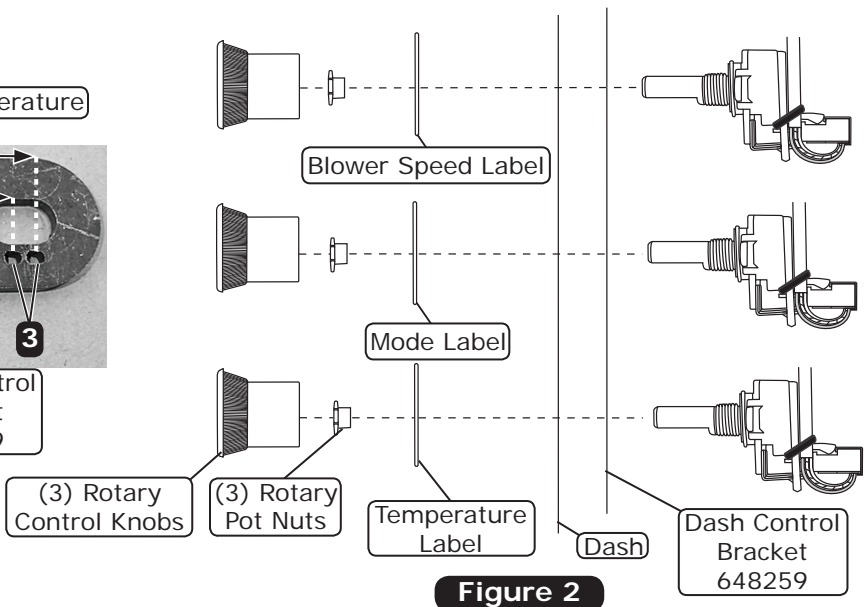
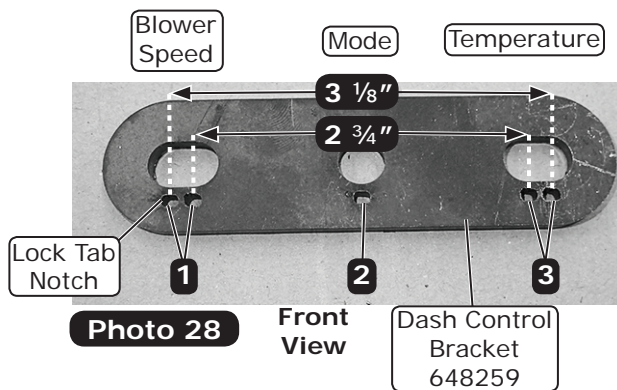





www.vintageair.com

## Evaporator Pre-Installation

1. Place the evaporator on a workbench. Locate the wiring on top of the evaporator unit, and carefully cut off the tie wraps that secure the wiring (See Photo 31, below).
2. Install the evaporator front driver side bracket onto the evaporator unit using (2) 1/4-20 x 1/2" bolts supplied on the evaporator unit (See Photo 32, below).
3. Install the evaporator front passenger side bracket onto the evaporator unit using (2) 1/4-20 x 1/2" bolts supplied on the evaporator unit (See Photo 33, below).
4. Disconnect the ECU from the evaporator unit by removing (5) connectors (See Photo 34, below). **NOTE: The 1st, 2nd and 3rd connectors are marked with dots for easy identification (See Photo 35, below). Review the location of each connector before removal for easy reconnection at the end of the evaporator installation process.**

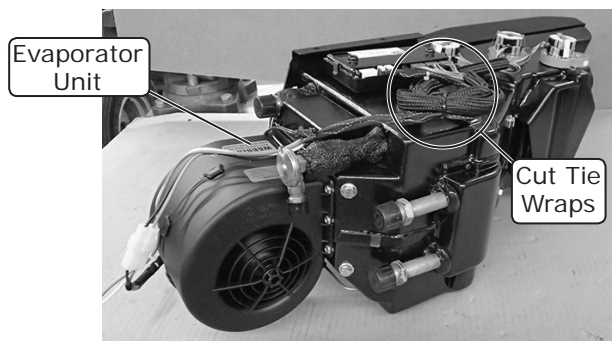

Photo 31

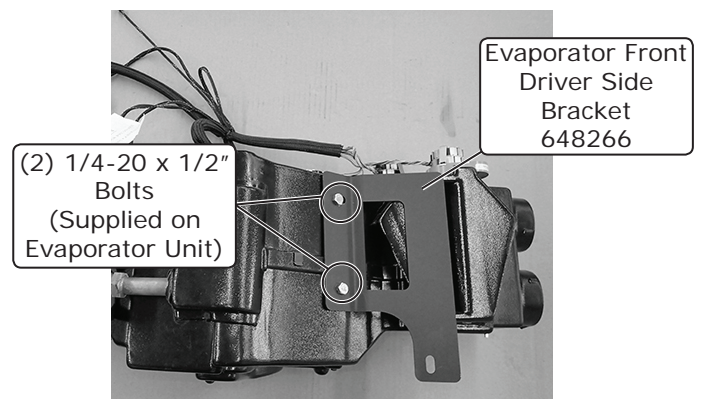

Photo 32

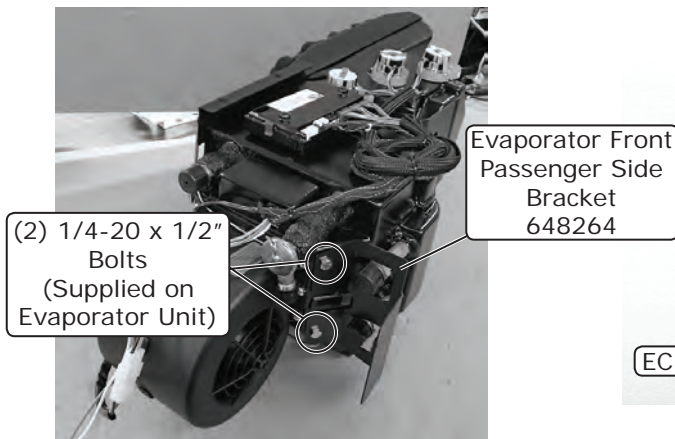

Photo 33

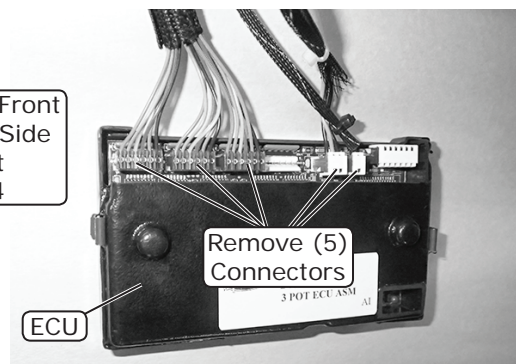

Photo 34

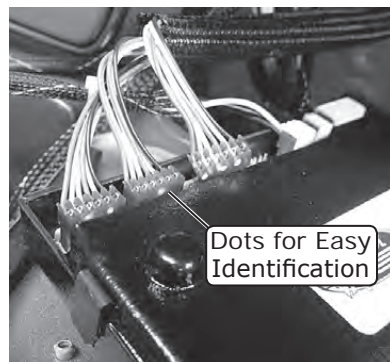

Photo 35

## Evaporator Pre-Installation (Cont.)

5. Install the heater hardlines onto the evaporator unit with properly lubricated O-rings (See Figure 6, Page 27, and Photo 36, below). **NOTE: The barb side of each heater hardline must be parallel with the top surface of the evaporator unit, because the hardlines will be installed through the firewall cover holes. Before tightening, use a ruler to align the hardlines (See Photos 36 and 37, below).**
6. Install a 1/4" x 1 1/2" stud halfway into the evaporator front passenger side bracket (See Photo 38, below). **NOTE: During installation, this will aid location of the previously drilled 3/8" hole on the firewall.**
7. Cut a 2" x 4" board to approximately 10 5/8", and place it on the passenger side floorboard. From the passenger compartment, lift up the evaporator unit, and insert the 1/4" x 1 1/2" stud into the 3/8" hole on the firewall. Temporarily secure the evaporator front passenger side bracket using a 1/4-20 nut (See Photo 40, below). Place the board under the evaporator unit on the right side, next to the drain outlet, to hold the unit in place against the glove box (See Photo 39, below). **NOTE: Do not place the board directly under the drain outlet, as it may break.**

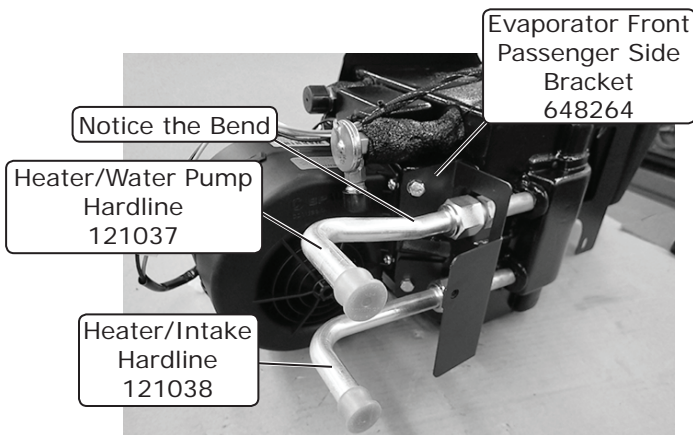

Photo 36

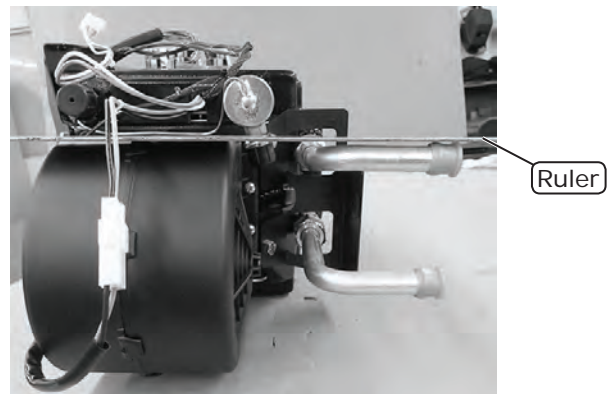

Photo 37

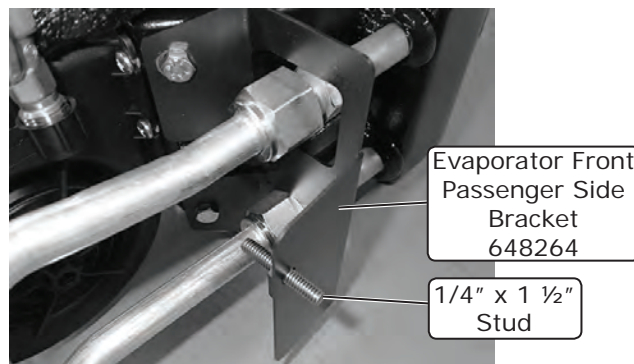

Photo 38

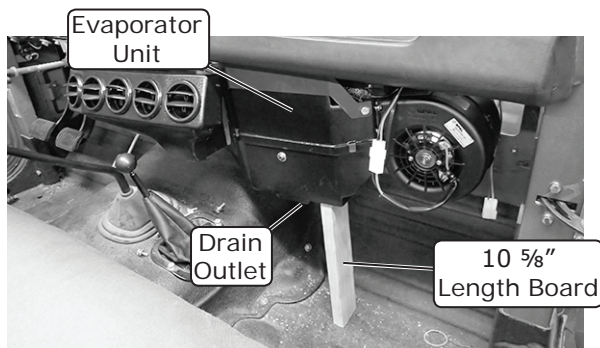

Photo 39

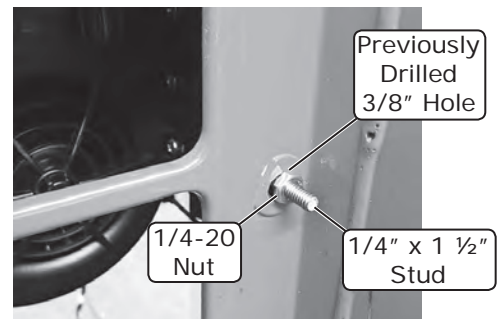

Photo 40



www.vintageair.com

## Evaporator Pre-Installation (Cont.)

8. From the driver side, temporarily secure the evaporator front driver side bracket using an OEM bolt (See Photo 41, below).
9. Level the evaporator unit (See Photo 42, below), making sure the mounting bolts are tight and the board is securely holding the unit against the glove box. Locate the firewall cover plate, and install it onto the firewall from the engine side while inserting the (2) heater lines through the firewall cover holes. Temporarily secure the plate using (4) OEM bolts, making sure the heater lines are centered in the holes (See Photo 43, below). If they are not centered, the heater lines will need to be adjusted on a workbench.

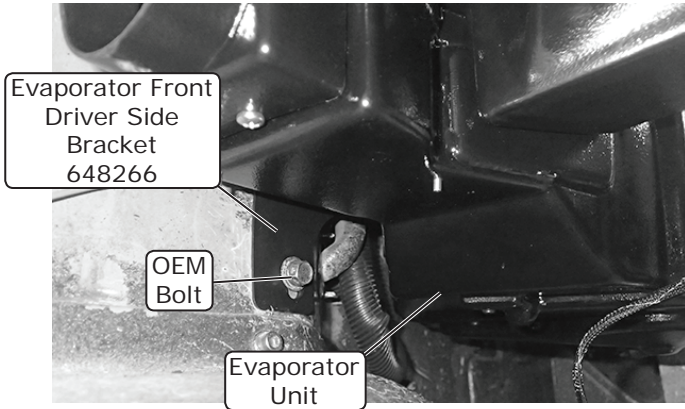

Photo 41

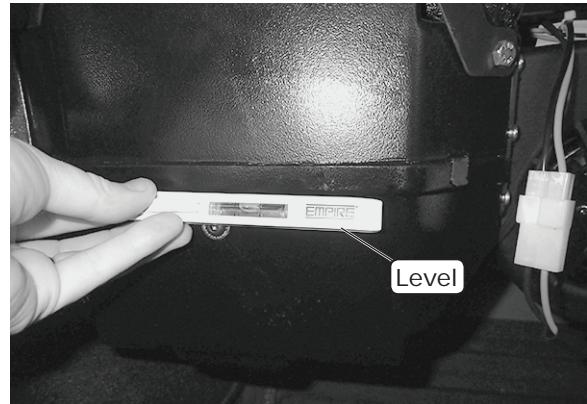

Photo 42

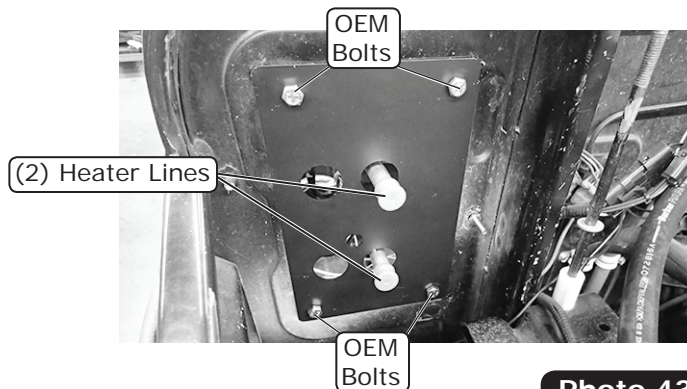

Photo 43



## Evaporator Pre-Installation (Cont.)

10. Push the louver bezel all the way back against the firewall (See Photo 44, below). While holding the bezel in place, use a pencil to draw a line onto the bottom of the glove box (behind the dash pad), using the edge of the evaporator rear bracket as a template (See Photos 44, 45, & 46, and Figure 3, below). Then draw a line into each of the (2) bracket notches to create (2) cross marks (See Photo 46 and Figure 3, below).
11. Remove (in order) the firewall cover plate, the 1/4-20 nut, the driver side mounting bolt, and the board. Place the evaporator unit on a workbench.
12. Locate the pencil crosses on the bottom of the glove box, and from each cross, measure 3/8" toward the firewall. Make (2) more marks, and drill (2) 5/16" holes at the new marks as shown in Photo 46, below.

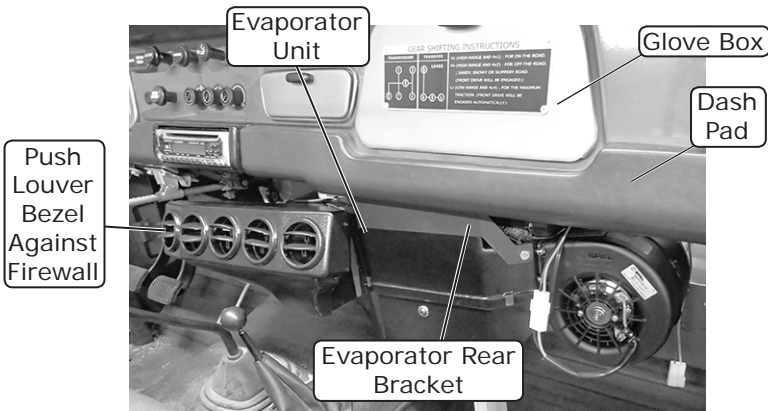

Photo 44

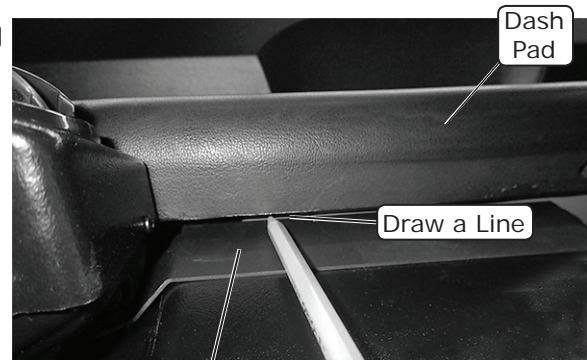

Photo 45

Draw a Line Using Bracket Edge

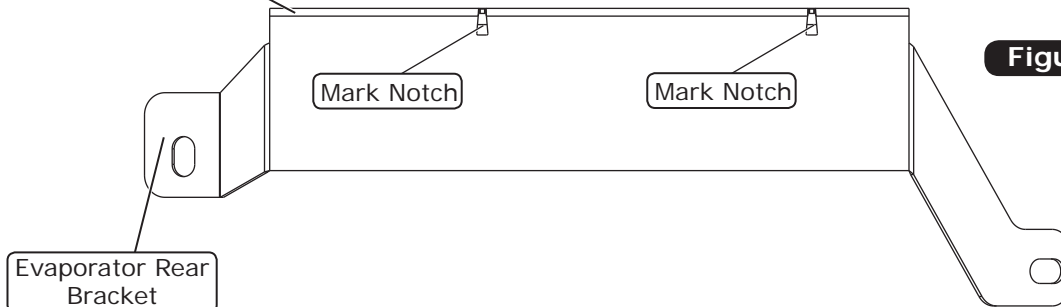
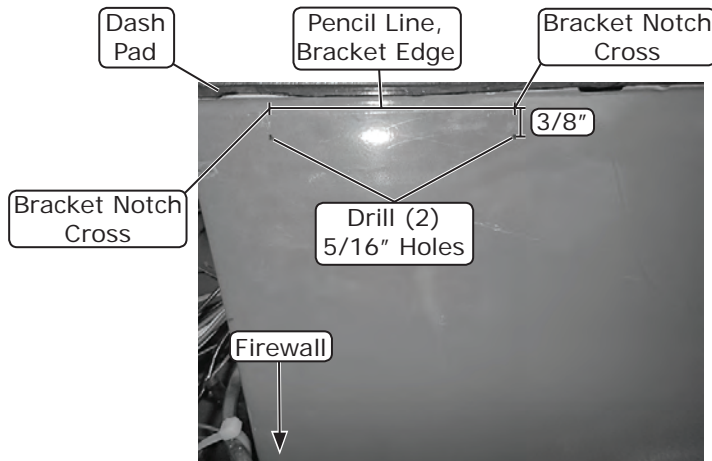

Figure 3



Under Glove Box View

Photo 46





www.vintageair.com

## Evaporator Pre-Installation (Cont.)

13. At this time, adjust the position of the heater lines if needed.
14. Using a properly lubricated O-ring, connect the 45° fitting on the #6 drier/evaporator A/C hose to the expansion valve on the evaporator unit. Center the hose between the blower and the heater hardlines, and tighten (See Figure 6, Page 27, and Photo 47, below).

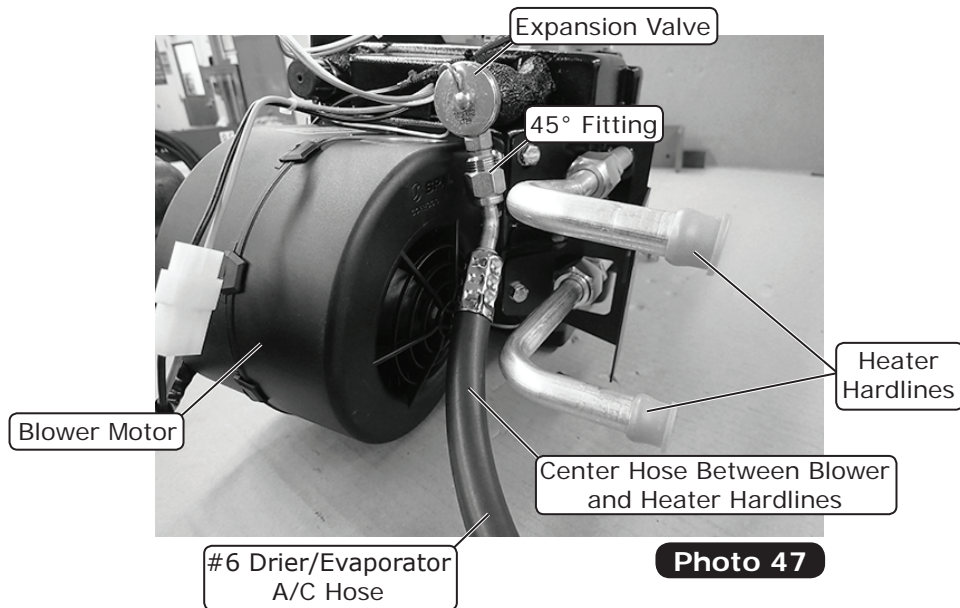

## Defrost Duct Hose Installation

1. Install (2) S-clips onto each duct hose adapter. Install 20 inches length of 2 ½" duct hose onto each hose adapter. The duct hose installs onto the barbed end of the hose adapter (See Photo 48, below).
2. Install the (2) hose adapters and hoses onto the OEM defrost ducts (See Photo 49, below). **NOTE: For side window defrost (not included in kit), a hose adapter (Part # 628190) is available for purchase from Vintage Air. A quantity of (2) is required.**

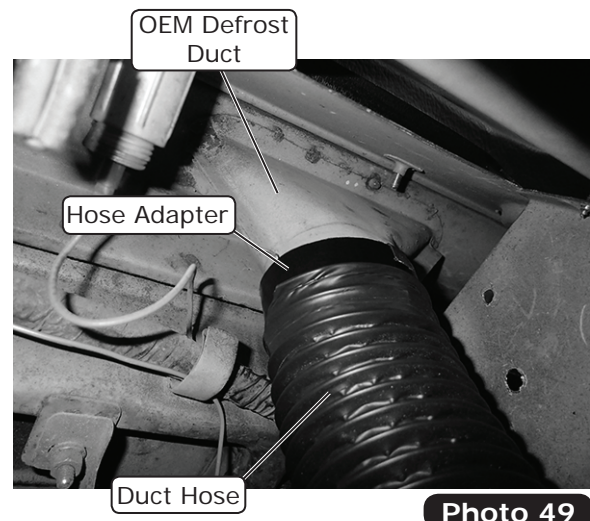
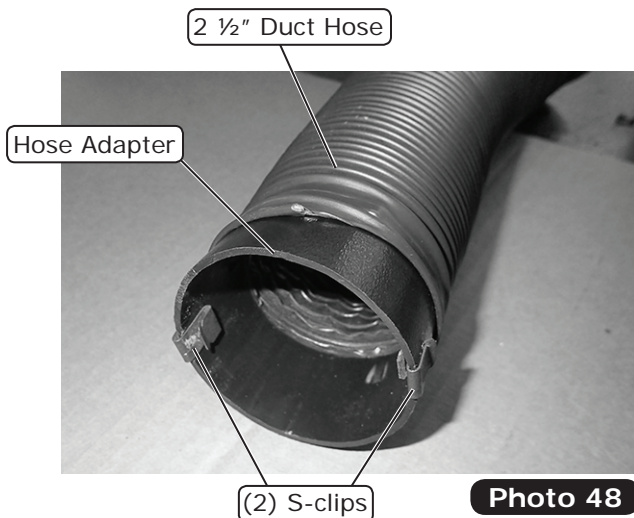



www.vintageair.com

## Wiring Installation

1. Locate the main wiring harness, and enlarge the relay mounting hole to a 1/4" (See Photo 50, below). Locate the heater control valve ground wire (white) (See Photo 51, below), and install the relay and the white ground wire onto the OEM weld nut located on the firewall next to the passenger side kick panel using an OEM bolt (See Photo 52, below).
2. Plug the white connector on the heater control valve adapter into the white connector on the main wiring harness (See Photo 53, below).

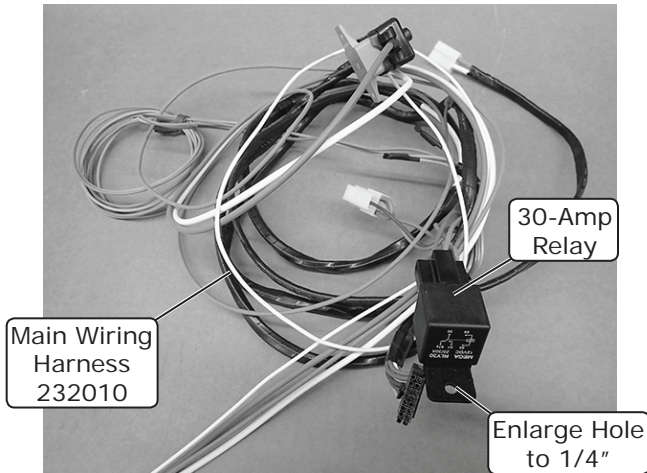

Photo 50

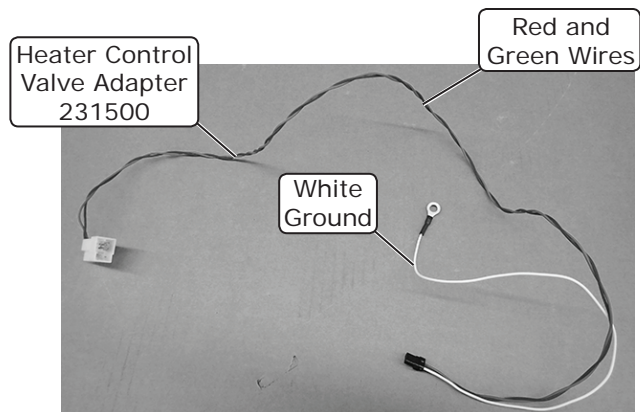

Photo 51

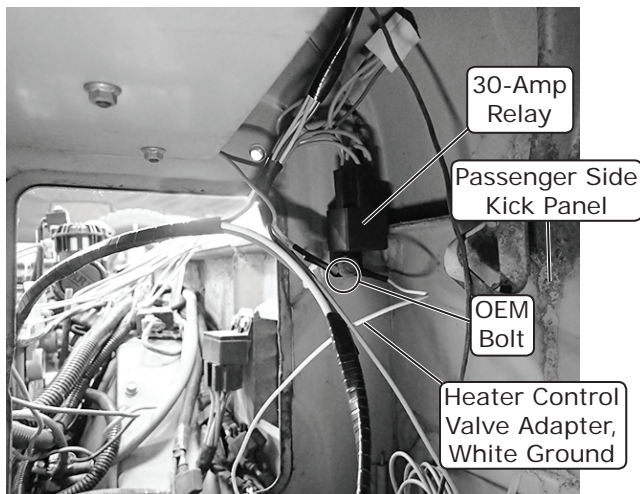

Photo 52

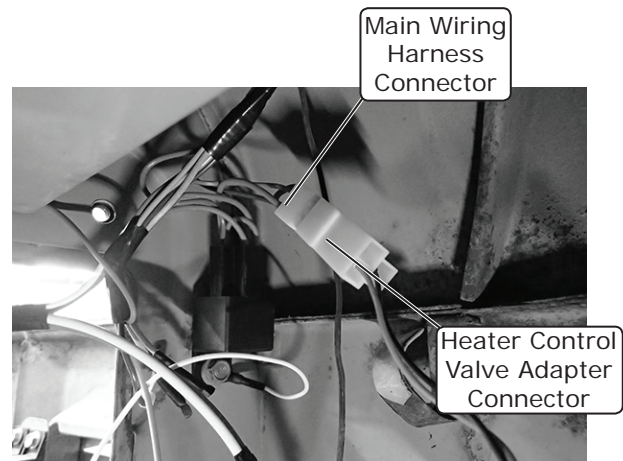

Photo 53





www.vintageair.com

## Wiring Installation (Cont.)

3. Route the purple wire on the main wiring harness through the right side of the glove box against the firewall, out the left side, and over to the fuse panel. Attach the female connector to the purple wire, and connect it to the 12v key-on in the fuse panel (See Photos 54, 55, & 56, below).
4. Route the ECU connector on the main wiring harness over the right side of the glove box (See Photos 57 & 58, below).
5. Route the wires from the main wiring harness (Red-White-Blue), and the heater control valve connector (Red-White-Green), through the smaller opening (lower) on the firewall (See Photo 59, below).

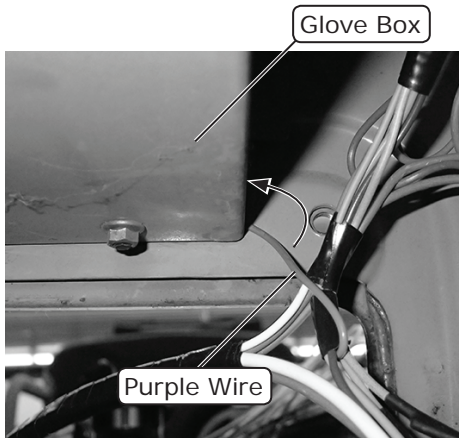

Photo 54

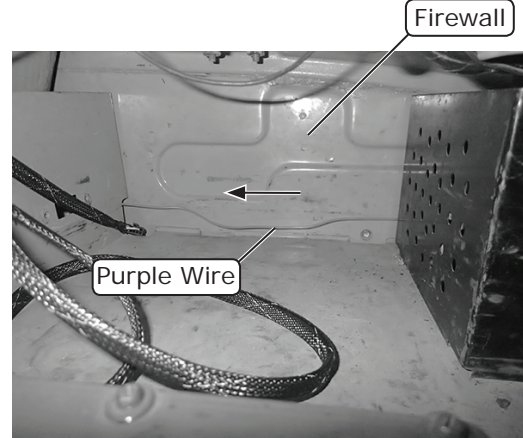

Photo 55

Glove Box View

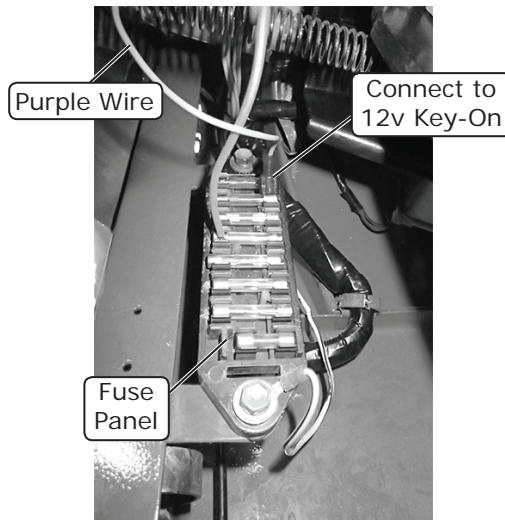

Photo 56

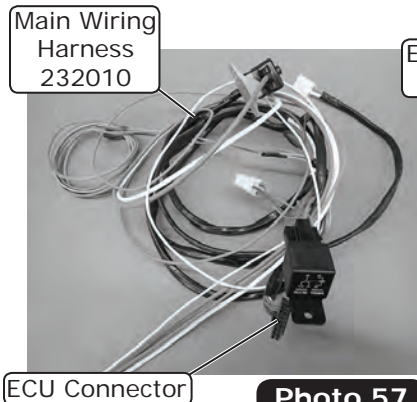

Photo 57

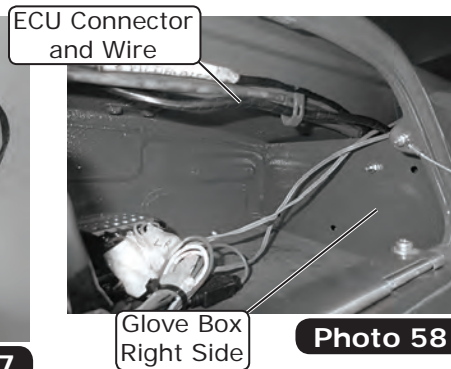

Photo 58

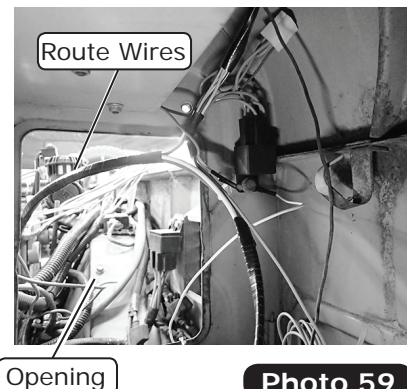

Photo 59



www.vintageair.com

## Evaporator Installation

**NOTE:** To ensure a watertight seal between the passenger compartment and the vehicle exterior, for all bolts passing through the firewall, Vintage Air recommends coating the threads with silicone prior to installation.

1. Place the evaporator unit onto the passenger side floorboard, and route the ECU wires (previously disconnected on Page 15) through the opening between the inner cowl and the left side of the glove box (See Photo 60, below). **NOTE: All wiring connections to the ECU will be made inside the glove box. The control panel connector will also plug into the ECU.**
2. Connect the defrost ducts to the defrost plenum on the evaporator unit. The driver side duct installs onto the lower opening on the plenum, and the passenger side duct installs onto the upper opening (See Photo 61, below).
3. Route the straight fitting on the #6 drier/evaporator A/C hose through the lower opening on the firewall (See Photo 64, below), and lift the evaporator unit into position (See Photos 62 & 63, below). Insert the 1/4" x 1 1/2" stud on the evaporator front passenger side bracket through the firewall, and secure it with a 1/4-20 nut (See Photo 65, below). **NOTE: The 1/4-20 nut can be installed from the passenger compartment through the firewall opening.**



Glove Box,  
Left Side

ECU Wires

Photo 60

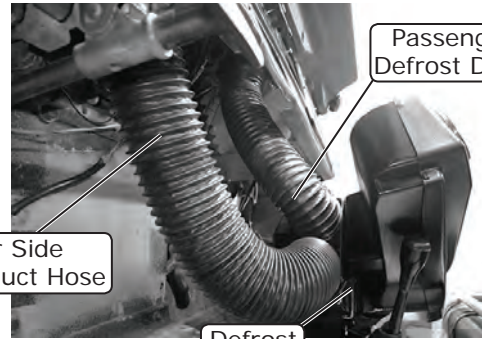

Passenger Side  
Defrost Duct Hose

Driver Side  
Defrost Duct Hose

Defrost  
Plenum

Photo 61



Photo 62

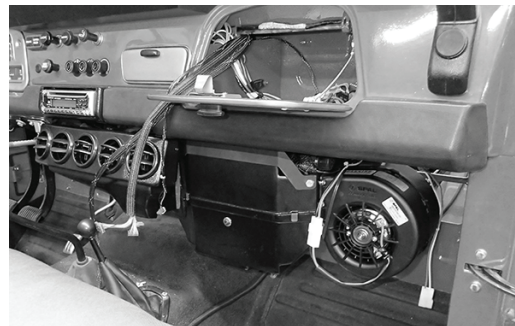
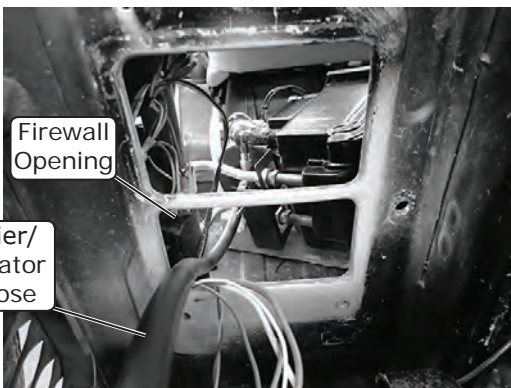

Photo 63



Firewall  
Opening

#6 Drier/  
Evaporator  
A/C Hose

Firewall,  
Engine Side View

Photo 64

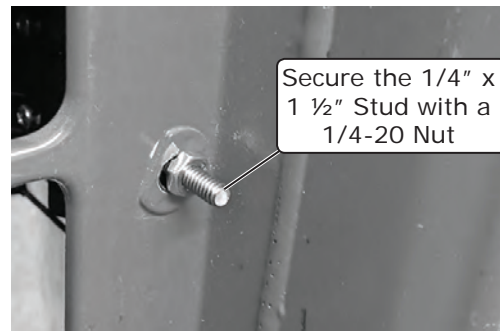

Secure the 1/4" x  
1 1/2" Stud with a  
1/4-20 Nut

Photo 65





www.vintageair.com

## Evaporator Installation (Cont.)

4. Secure the evaporator front driver side bracket to the firewall using an OEM bolt (See Photo 66, below).
5. From the inside the glove box, secure the evaporator rear bracket to the bottom of the glove box using (2) 1/4-20 x 1/2" hex bolts and (2) 1/4" washers (See Photos 67 & 68, below).
6. Once the evaporator brackets are secured, remove the 1/4" x 1 1/2" stud from the evaporator front passenger side bracket, and replace it with a 1/4-20 x 1/2" hex bolt and a sleeve washer (See Photo 69, below).

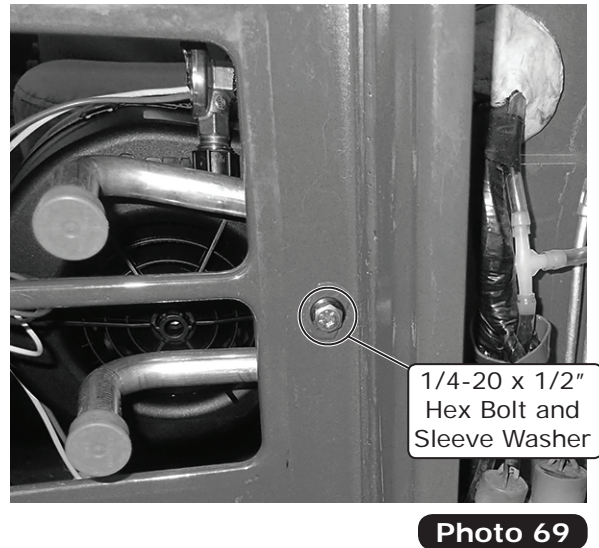
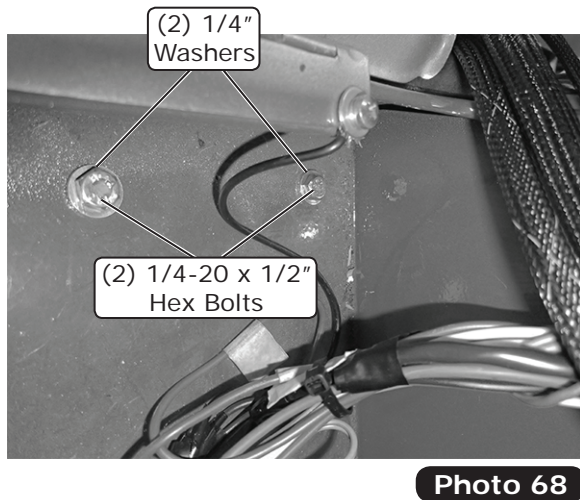
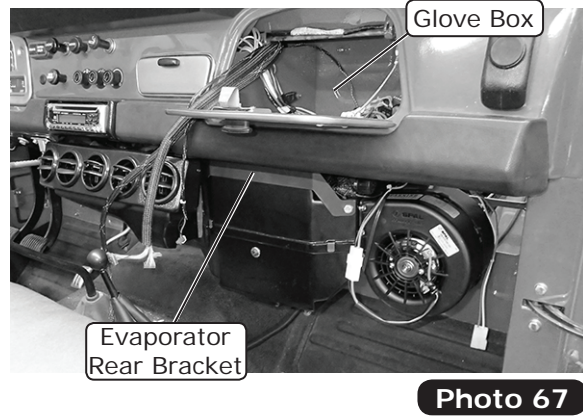
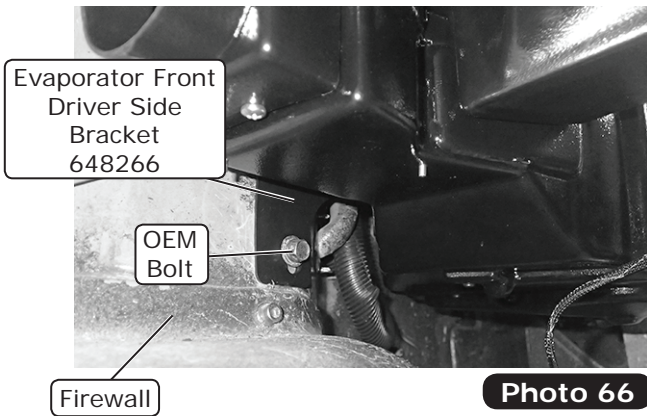



www.vintageair.com

## Drain Hose Installation

1. Locate the upper right bolt on the transmission cover where it meets the firewall (See Photo 70, below). Using the measurements in Photo 71, below, mark and drill a 5/8" hole. Deburr the hole (See Photo 72, below).
2. Install the drain elbow onto one end of the drain hose and, from the engine side, insert the drain hose through the 5/8" hole in the firewall (See Photos 73 & 74, below). From the passenger compartment, cut the hose as needed, and install the drain hose onto the drain outlet on the evaporator (See Photos 75 & 76, below).



Photo 70

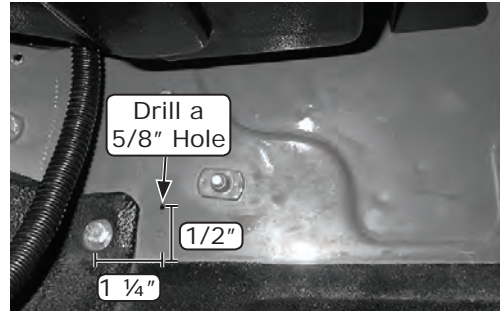

Photo 71

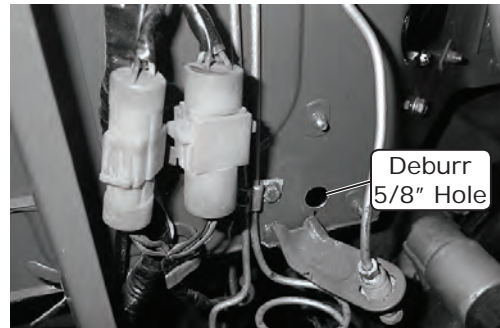

Photo 72

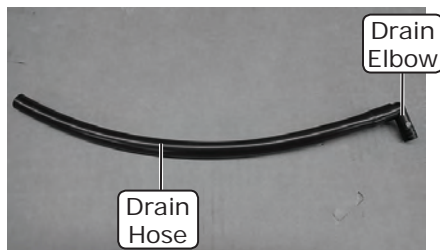
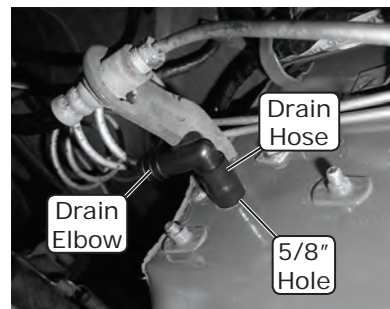

Photo 73



Firewall,  
Engine Side  
View

Photo 74

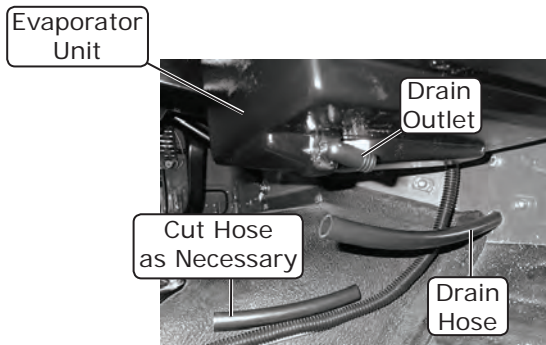
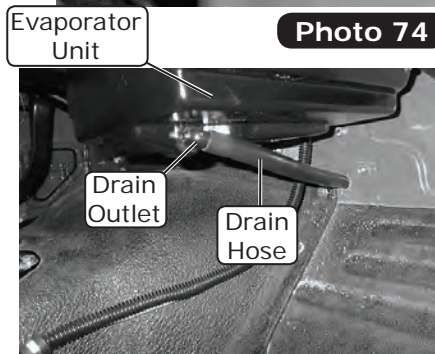

Photo 75



Firewall,  
Passenger  
Compartment  
View

Photo 76





www.vintageair.com

## Engine Compartment Hose and Wiring Connections

1. Install (4) grommets onto the firewall cover, and route the #6 drier/evaporator A/C hose through the firewall cover as shown in Photo 77, below. Then, from the engine side, route the 45° fitting on the #10 compressor/evaporator A/C hose through the firewall cover as shown in Photo 77, below. **NOTE: Soapy water may be used to ease insertion of the A/C hoses through the grommets, but be sure the hoses are capped to prevent water from getting inside.**
2. Using a properly lubricated O-ring, connect the 45° fitting on the #10 compressor/evaporator A/C hose to the #10 fitting on the evaporator unit (See Figure 6, Page 27, and Photo 78, below). Install press tape around the #10 fitting as shown in Photo 79, below.
3. Route the heater control valve connector through the 5/8" hole on the firewall cover as shown in Photo 80, below. Install a 3/8" grommet over the heater control valve connector and into the 5/8" hole in the firewall cover (See Photos 80 & 81, below). Then, route the wires from the main wiring harness (Red-White-Blue) through the 3/8" grommet as shown in Photo 82, below.
4. Apply a bead of silicone around the mating surface of the firewall cover, and install it using (4) OEM bolts (See Figure 4 and Photo 83, below). **NOTE: After tightening the bolts, add more silicone around the edge of the firewall cover.**

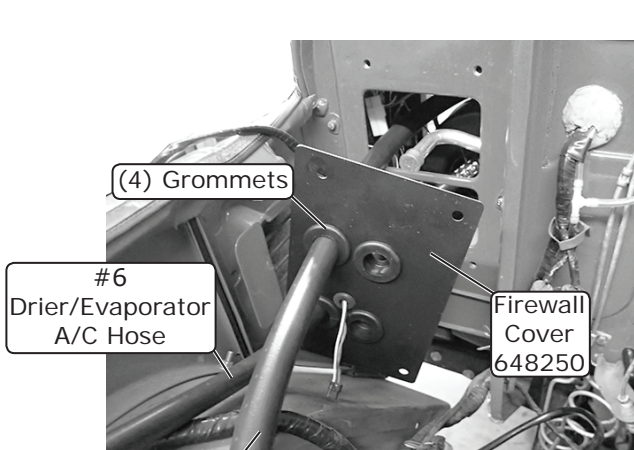

Photo 77

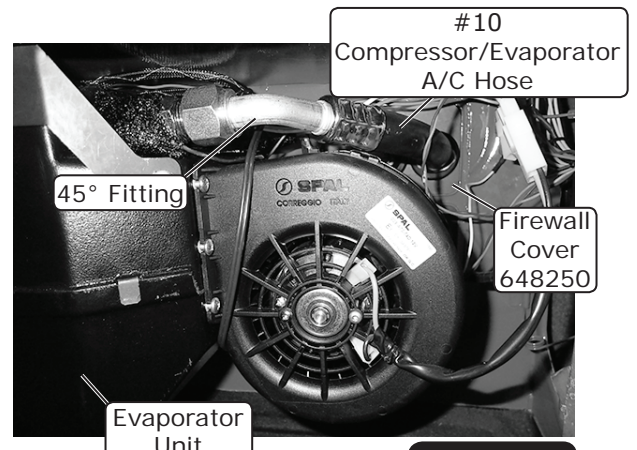

Photo 78

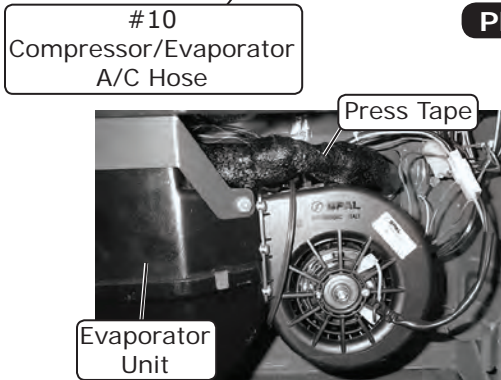

Photo 79

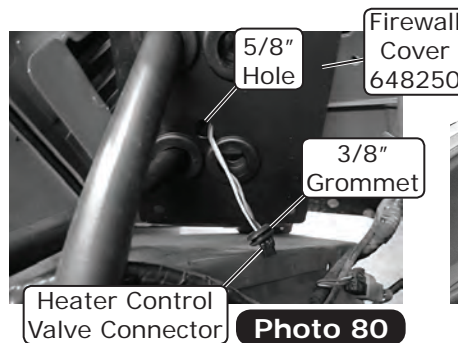

Photo 80

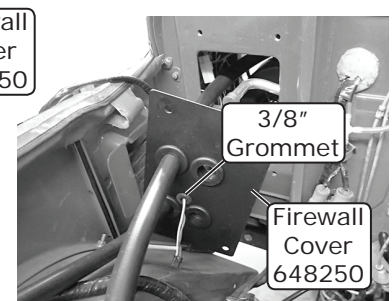

Photo 81

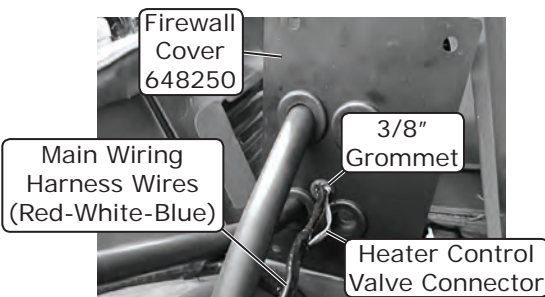

Photo 82

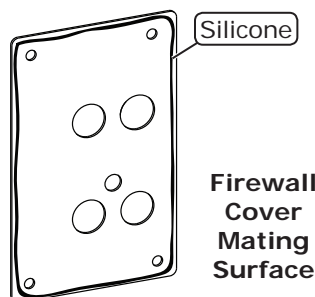

Figure 4

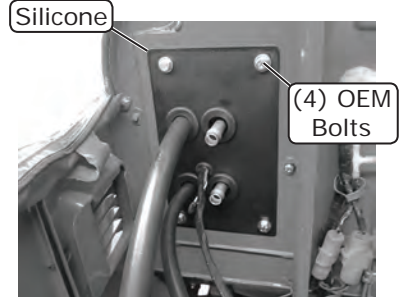

Photo 83



## Engine Compartment Hose and Wiring Connections (Cont.)

5. Route a piece of 5/8" heater hose from the water pump to the upper heater hardline at the firewall, and secure both ends with hose clamps (See Photo 84, below).
6. Cut an 8" piece of 5/8" heater hose and attach it to the heater control valve. Secure it with a hose clamp. Install the other end of the 8" heater hose onto the lower heater hardline at the firewall. Secure it with a hose clamp. Route one more piece of heater hose from the intake manifold (pressure side) to the heater control valve, and secure both ends with hose clamps (See Photos 84 & 85, and Figure 5, below). Plug the connector on the heater control valve into the corresponding connector coming from the firewall. **NOTE: Ensure proper flow direction through the heater control valve (the flow direction follows the molded arrow on the valve).**
7. Mount the circuit breaker near the battery. Attach eyelet connectors to the red wire and the white ground wire. Attach the white ground wire to the negative battery terminal (See Photo 86, below). Attach the red wire to the positive battery terminal (See Photo 86, below).
8. Connect the blue wire on the main wiring harness to the binary switch on the drier. **NOTE: It does not matter which of the (2) connectors on the binary switch is used (See Photo 87, below).**
9. Connect one end of the blue compressor lead wire (supplied in the condenser kit) to the binary switch, and the other end to the black wire on the compressor (See Photo 88, below). Secure the wiring along the #8 condenser/compressor hose using (4) tie wraps.

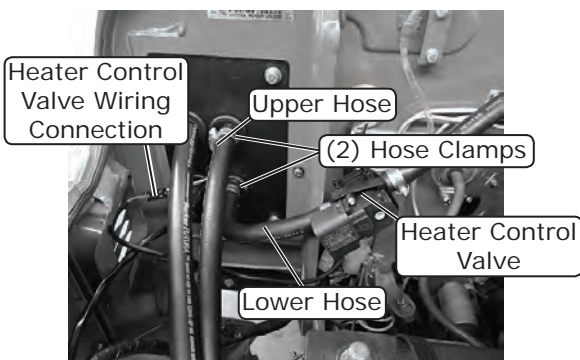

Photo 84

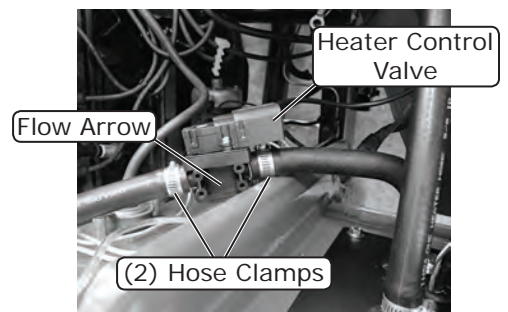
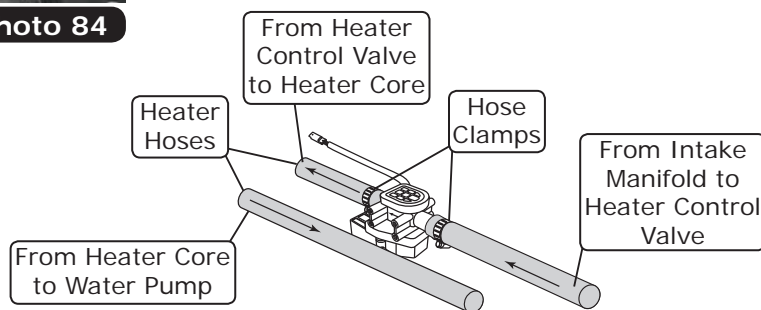

Photo 85



**NOTE: Flow Direction Follows Molded Arrow on Valve.**

Figure 5

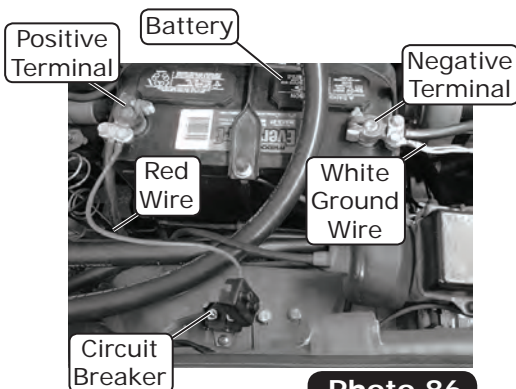

Photo 86

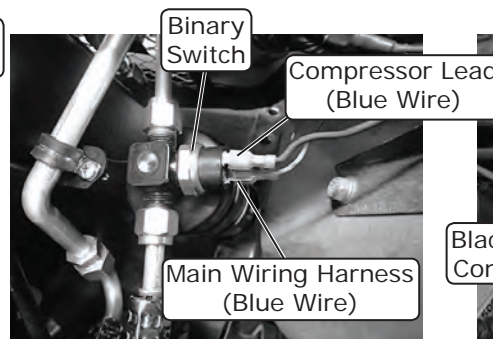

Photo 87

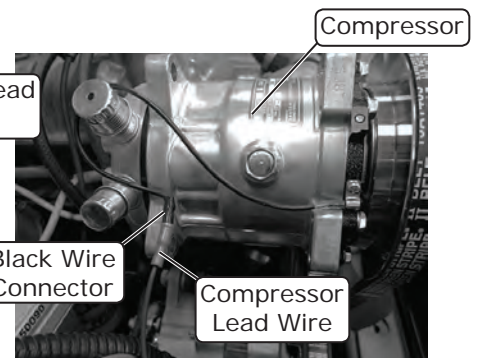
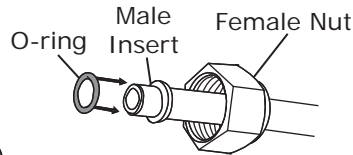
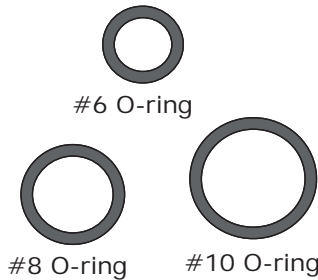

Photo 88



www.vintageair.com

## Lubricating O-rings



For a proper seal of fittings: Install supplied O-rings as shown, and lubricate with supplied oil.

**Figure 6**

**NOTE: Standard torque specifications:**  
 #6: 11 to 13 ft-lb.  
 #8: 15 to 20 ft-lb.  
 #10: 21 to 27 ft-lb.

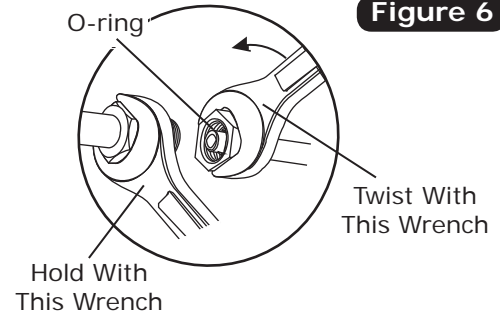
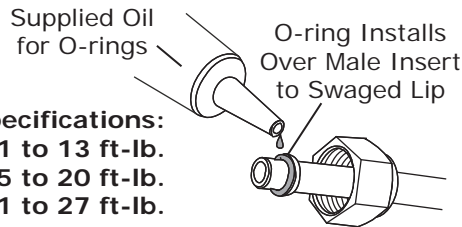

## A/C Hose Installation

### Standard Hose Kit:

1. Locate the #6 drier/evaporator A/C hose. Lubricate a #6 O-ring (See Figure 6, above), and connect the #6 straight fitting to the drier (See Photo 89, below). Tighten the fitting connection as shown in Figure 6, above.
2. Locate the #8 condenser/compressor A/C hose. Lubricate (2) #8 O-rings (See Figure 6, above), and connect the 45° fitting with service port to the #8 discharge port on the compressor (See Photo 90, below). Route the 135° fitting to the #8 condenser/core hardline (See Photo 89, below). Tighten each fitting connection as shown in Figure 6, above.
3. Locate the #10 compressor/evaporator A/C hose. Lubricate a #10 O-ring (See Figure 6, above), and connect the #10 135° fitting with service port to the #10 suction port on the compressor (See Photo 90, below). Tighten the fitting connection as shown in Figure 6, above.

### Modified Hose Kit:

1. Refer to separate instructions included with modified hose kit.

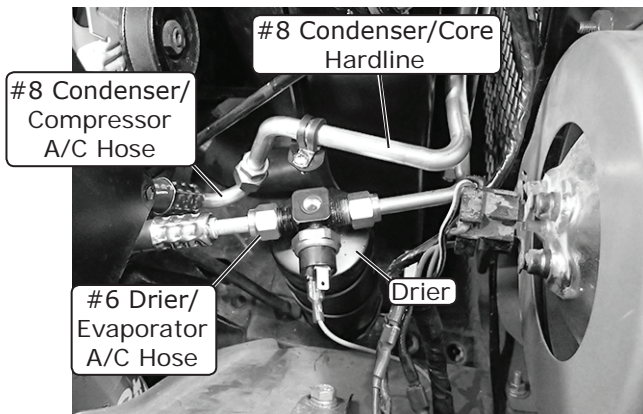

**Photo 89**

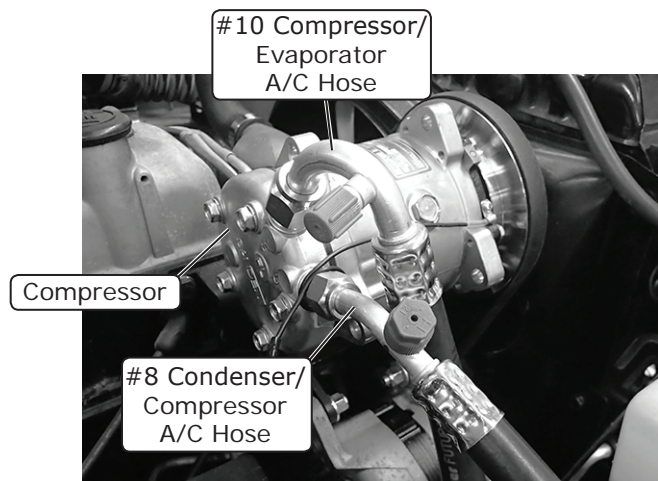

**Photo 90**





www.vintageair.com

## A/C and Heater Hose Routing

**NOTE:** Vintage Air Systems use 5/8" heater connections. On engines equipped with 3/4" hose nipples, these will need to be removed and replaced with 5/8" nipples (not supplied). For water pumps with a cast-in 3/4" heater outlet, a 3/4" x 5/8" reducer fitting (not supplied) or molded hose (Vintage Air Part # 099010) will need to be installed in the heater hose.

**NOTE:** Flow Direction Follows Molded Arrow on Valve.

Heater Hose (Heater Core/Water Pump)

Heater Control Valve

Heater Hose (Heater Control Valve/Intake)

Heater Hose (Heater Core/Heater Control Valve)

#10 Compressor/Evaporator A/C Hose

#8 Condenser/Compressor A/C Hose

#6 Drier/Evaporator A/C Hose

#8 Condenser/Core Hardline

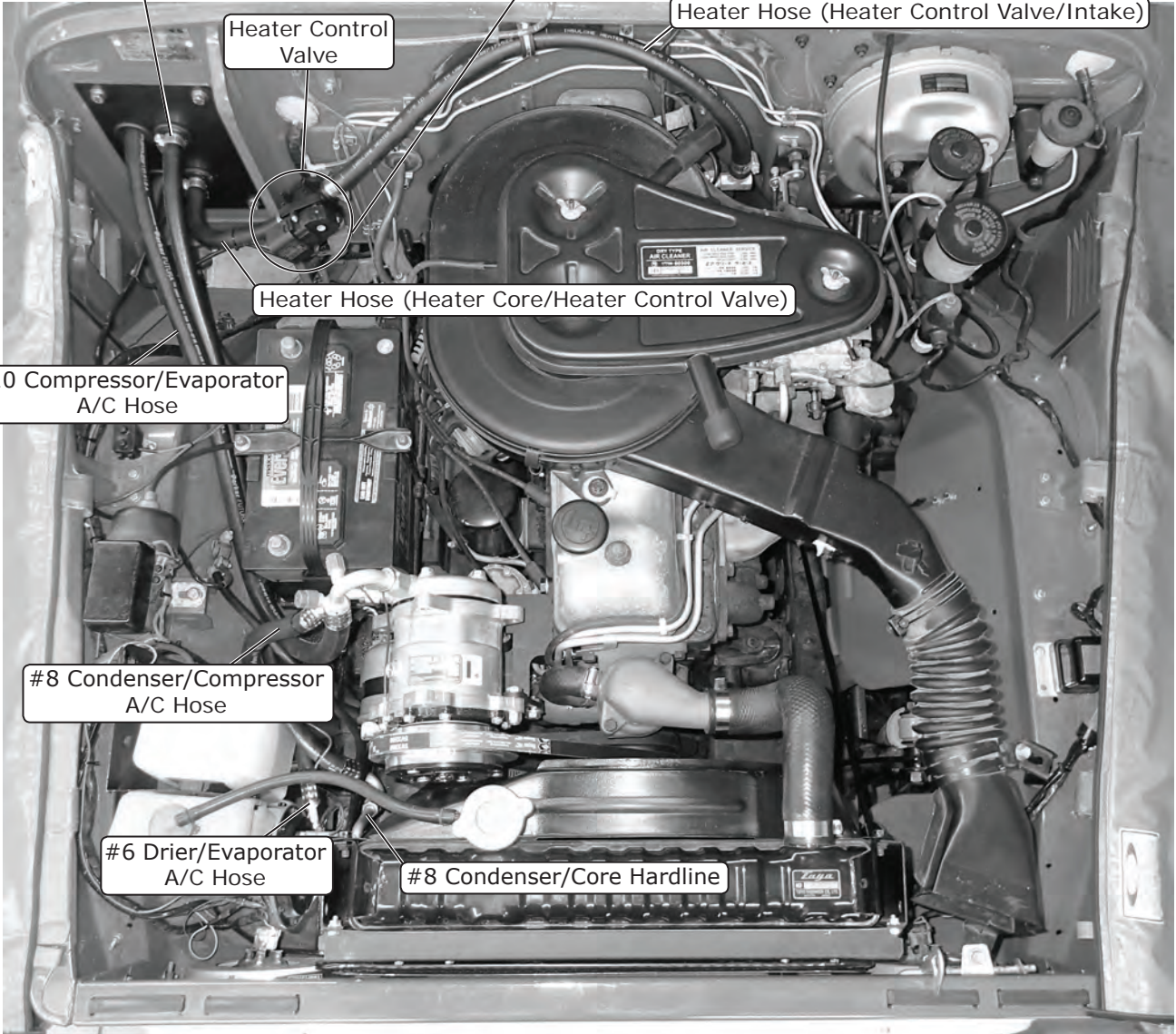

Photo 91



www.vintageair.com

## ECU & ECU Bracket Installation

1. Place the ECU bracket on top of the glove box door. Route control panel connector and the black connector from the main wiring harness through the opening of the bracket, and plug them into the ECU as shown in Photos 92 & 93, below.
2. Plug the (5) evaporator connectors into the ECU (these (5) connectors were disconnected on Page 15) (See Photos 94 & 95, below). **NOTE: Be sure to reinstall the connectors in the original place, original order, and correctly onto the pins. The ECU bracket has dots engraved onto it to determine the locations of the first (3) connectors (See Figure 7, below).**

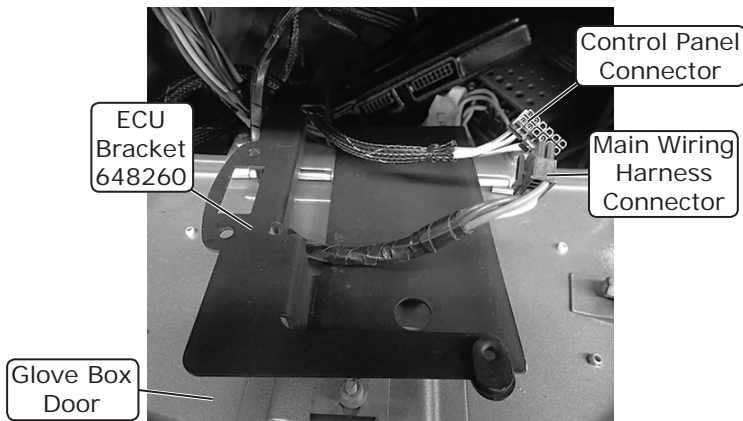

Photo 92

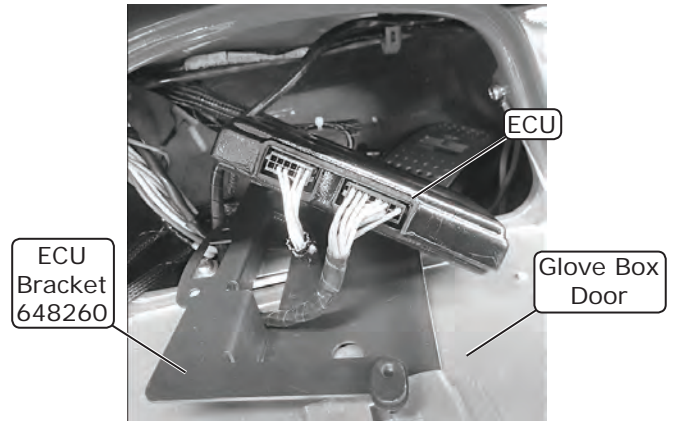

Photo 93

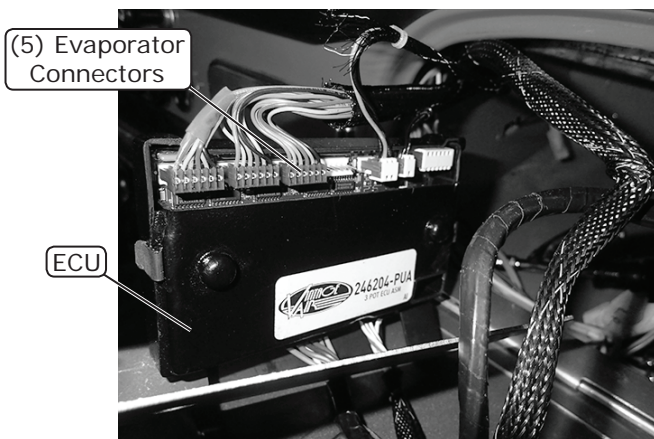

Photo 94

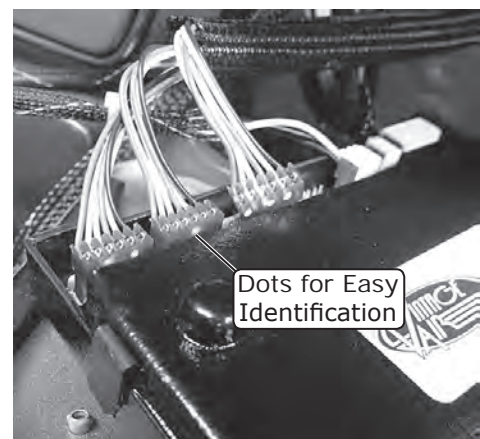

Photo 95

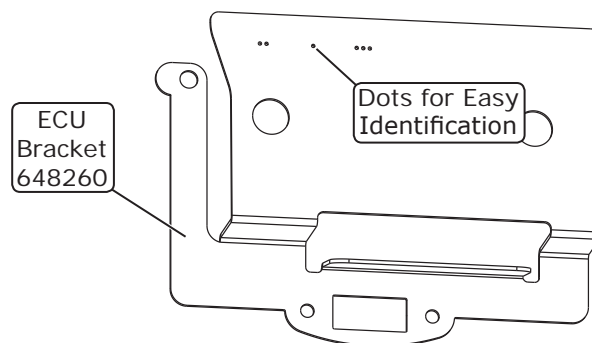

Figure 7





www.vintageair.com

## ECU & ECU Bracket Installation (Cont.)

3. Route the (2) wiring harnesses along the ECU bracket, and secure them using a #2 Adel clamp and a 10-24 x 1/2" screw (See Photo 96, below).
4. Place the OEM AC outlet onto the ECU bracket (See Photo 96, below), and reconnect the AC outlet (See Photo 97, below). Install the ECU bracket assembly in the original OEM AC outlet mounting location on the inner left wall of the glove box, and secure it using (2) M4 x 0.7 x 12mm hex bolts (See Photos 97 & 98, below).

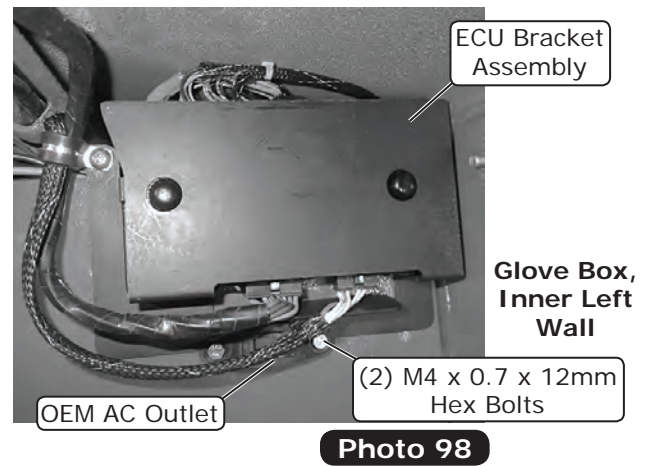
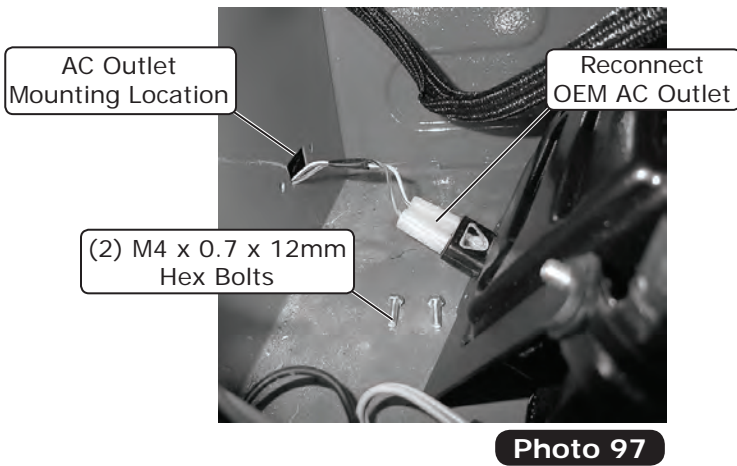
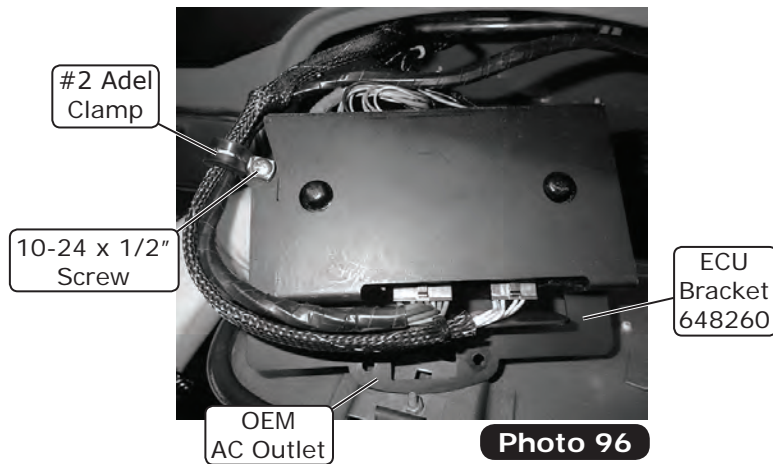

## Dash Pad Filler Installation

**NOTE: A dash pad filler piece is included to fill the gap between the top of the evaporator louver bezel and the bottom of the dash. Because there are different dash pad lengths, the filler piece may need to be trimmed for a proper fit.**

1. Once the evaporator unit is completely installed, place the dash pad filler on top of the louver bezel. Measure the length of the dash pad, and trim the filler piece as necessary. Vintage Air includes a choice of (3) #6 x 1/4" screws and 20" of double-sided tape to attach the dash pad filler to the louver bezel.

### NOTES:

- A. If using the (3) #6 x 1/4" screws, remove the louver bezel (front of the assembly) by removing (5) screws: (2) on the right, (2) on the left, and (1) at the bottom. Install the filler piece, and reinstall the louver bezel using the same (5) screws.
- B. For Toyota FJ40 models without an OEM dash pad, install the filler piece without trimming.



www.vintageair.com

## Louver Bezel Support Bracket Installation

1. Remove the (2) OEM bolts from the emergency brake bracket (See Photo 99, below).
  2. Insert the louver bezel support bracket between the emergency brake bracket and the bottom of the dash. Adjust the brackets as needed, and reinstall the (2) OEM bolts (See Photo 100, below).
  3. Lift the left side of the louver bezel against the bottom of the dash, and install a #6 x 1/4" screw through the louver bezel support bracket and into the hole on the left side of the louver bezel (See Photo 100, below).
- NOTE: Apply silicone to the threads of the #6 x 1/4" screw prior to installation.**

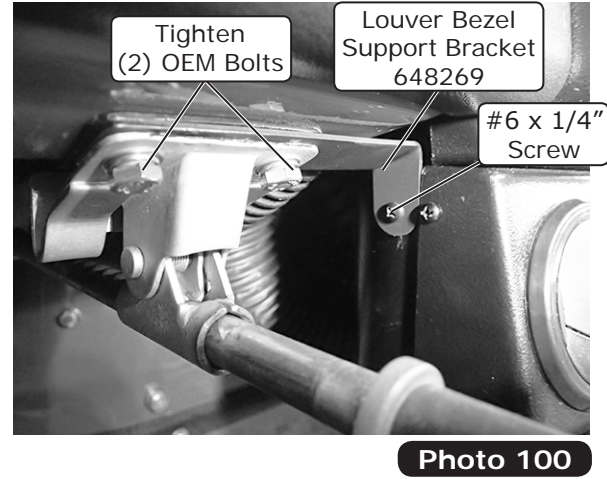
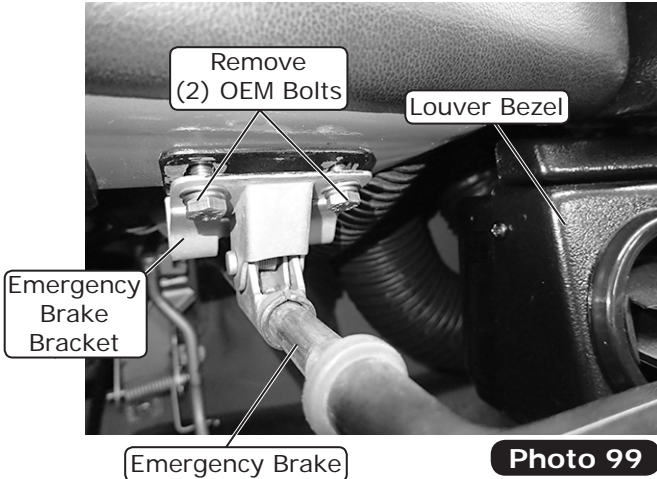

## Final Steps

1. Reinstall all previously removed items.
2. Fill radiator with at least a 50/50 mixture of approved antifreeze and distilled water. It is the owner's responsibility to keep the freeze protection at the proper level for the climate in which the vehicle is operated. Failure to follow antifreeze recommendations will cause heater core to corrode prematurely and possibly burst in A/C mode and/or freezing weather, voiding your warranty.
3. Double check all fittings, brackets and belts for tightness.
4. Vintage Air recommends that all A/C systems be serviced by a licensed automotive A/C technician.
5. Evacuate the system for a minimum of 45 minutes prior to charging, and perform a leak check prior to servicing.
6. Charge the system to the capacities stated on Page 4 of this instruction manual.
7. See Operation of Controls procedures on Page 34.



www.vintageair.com

# Evaporator Under Dash Cover Installation (Optional)

1. Remove (2) bolts from the evaporator as shown in Photo 101, below.
2. Loosen the relay bolt on the firewall (See Photo 102, below).
3. Install the evaporator cover support bracket onto the evaporator cover using (2) 10-24 screws ((1) at the top and (1) at the bottom) (See Photos 103, 104 and 105, below).
4. Place the evaporator cover assembly under the dash, and slide the bracket slot between the relay and the firewall (See Photos 105 and 106, below).
5. Install the evaporator cover assembly in front of the evaporator unit, and secure it using (2) 1/4-20 Allen screws. **NOTE: The 1/4-20 hex bolt securing the rear bracket to the evaporator unit will be replaced by a 1/4-20 Allen screw supplied in the accessory kit (See Photo 107, below).**
6. Tighten the relay bolt.

Remove (2) Bolts from Evaporator Unit

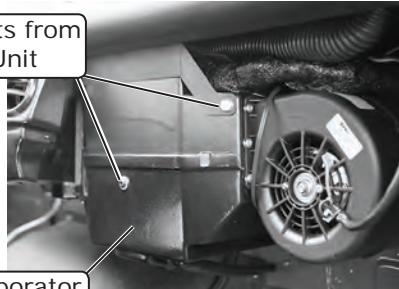

Evaporator Unit

Photo 101

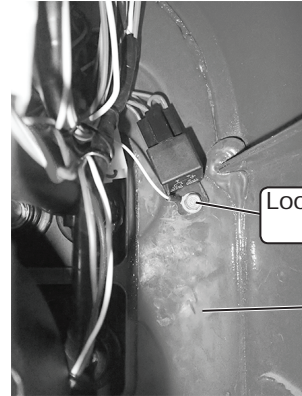

Loosen Relay Bolt

Firewall

Photo 102

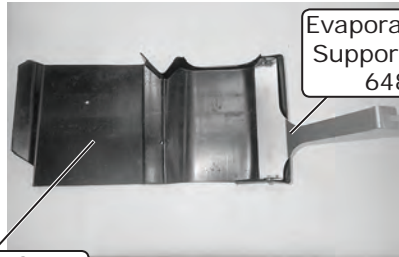

Evaporator Cover Support Bracket 648248

Photo 103



(2) 10-24 Screws

Photo 104

Evaporator Cover Assembly 628189

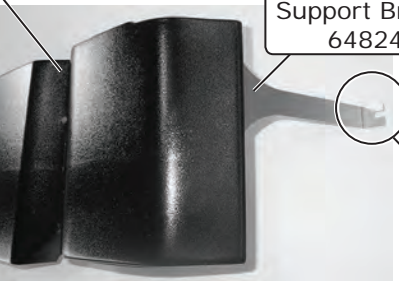

Evaporator Cover Support Bracket 648248

Bracket Slot

Photo 105

Evaporator Cover Support Bracket 648248

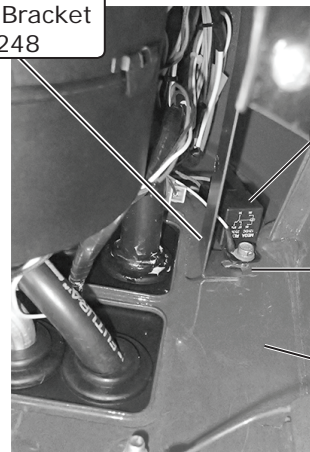

Relay

Place Bracket Slot Between Relay and Firewall

Firewall

Photo 106



Evaporator Cover Assembly 628189

(2) 1/4-20 Allen Screws

Photo 107





www.vintageair.com

# Wiring Diagram

## 232007-VUR

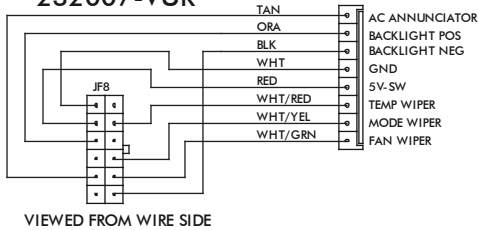

VIEWED FROM WIRE SIDE

## 232002-VUA

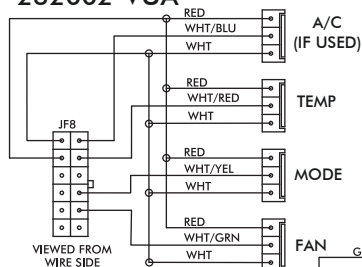

VIEWED FROM WIRE SIDE

## GEN IV ECU

GEN IV WIRING DIAGRAM  
REV D, 5/6/2014

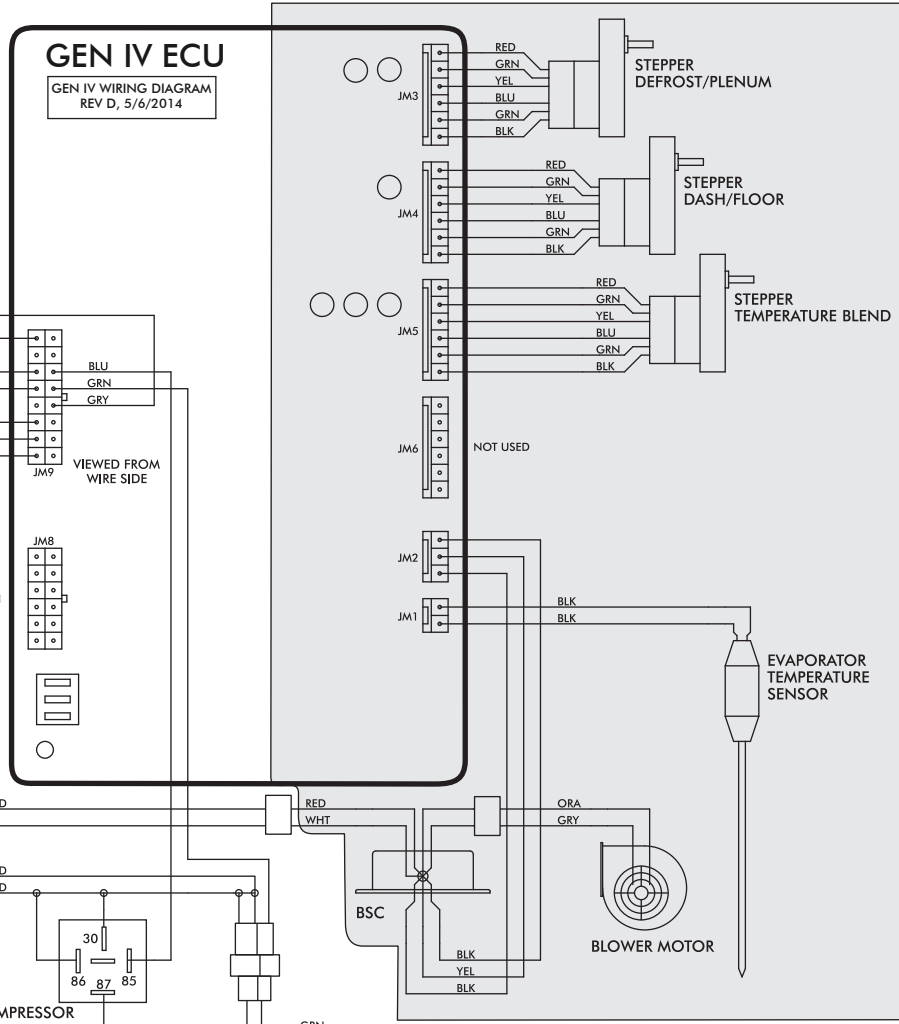

PRE-WIRED

### PROGRAM

N/A  
\* DASH LAMP (IF USED)

\*\*\* WIDE OPEN THROTTLE SWITCH (OPTIONAL)

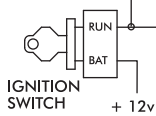

IGNITION SWITCH +12v

\*\* CIRCUIT BREAKER 30 AMP

COMPRESSOR RELAY

BINARY OR TRINARY SAFETY SWITCH

CMPR

HEATER CONTROL VALVE

NOTE: = CHASSIS GROUND

- Dash Lamp Is Used Only With Type 232007-VUR Harness.
- Warning: Always Mount Circuit Breaker As Close to the Battery As Possible. (NOTE: Wire Between Battery and Circuit Breaker Is Unprotected and Should Be Carefully Routed to Avoid a Short Circuit).
- Wide Open Throttle Switch Contacts Close Only at Full Throttle, Which Disables A/C Compressor.



www.vintageair.com

# Gen IV Wiring Connection Instruction

WIRING HARNESS

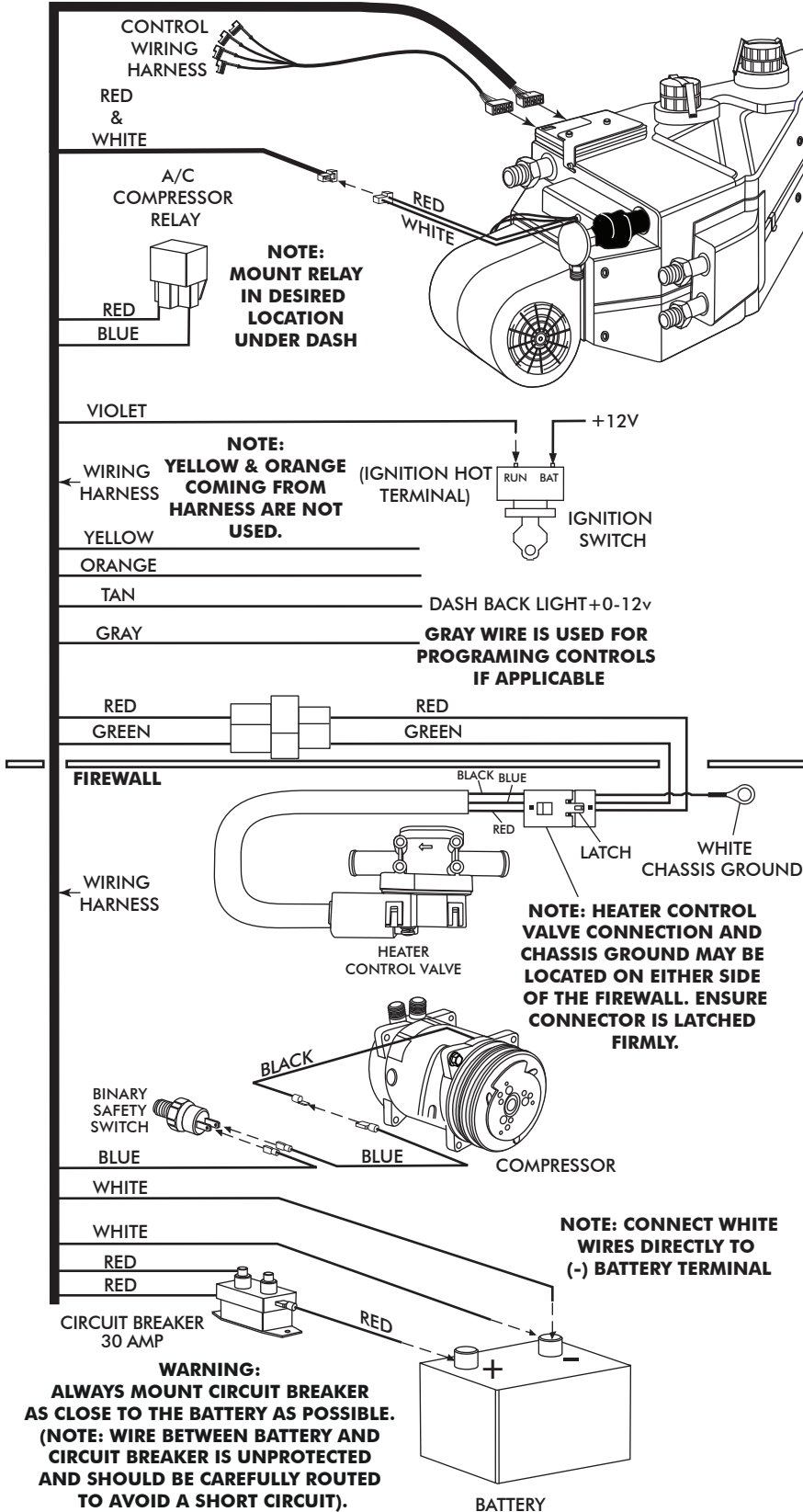

**Ignition Switch:**  
Violet 12V Ign Switch Source (Key On Accessory) Position Must Be Switched.

**Dash Light:**  
Tan Wire Used Only With Vintage Air Supplied Control Panel With LED Back Light.

**Heater Control Valve:**  
Install With Servo Motor Facing Down, As Shown. Note Flow Direction Arrow Molded Into Valve Body, And Install Accordingly.

**Binary/Trinary & Compressor:**  
Binary: Connect As Shown (Typical Compressor Wiring). Be Sure Compressor Body Is Grounded.  
Trinary Switch: Connect According To Trinary Switch Wiring Diagram.

**Circuit Breaker/Battery:**  
White **Must** Run To (-) Battery. Red May Run To (+) Battery Or Starter. Mount Circuit Breaker As Close to Battery As Possible.

**WARNING:**  
ALWAYS MOUNT CIRCUIT BREAKER AS CLOSE TO THE BATTERY AS POSSIBLE. (NOTE: WIRE BETWEEN BATTERY AND CIRCUIT BREAKER IS UNPROTECTED AND SHOULD BE CAREFULLY ROUTED TO AVOID A SHORT CIRCUIT).



www.vintageair.com

## Operation of Controls

On Gen IV systems with three lever/knob controls, the temperature control toggles between heat and A/C operations. To activate A/C, move the temperature lever/knob all the way to cold and then back it off to the desired vent temperature. For heat operation, move the temperature lever/knob all the way to hot and then adjust to the desired vent temperature. The blower will momentarily change speed, each time you toggle between operations, to indicate the change.

### Blower Speed

This lever/knob controls blower speed, from OFF to HI.

### Mode Control

This lever/knob controls the mode positions, from DASH to FLOOR to DEFROST, with a blend in between.

### Temperature Control

This lever/knob controls the temperature, from HOT to COLD.

Blower Speed

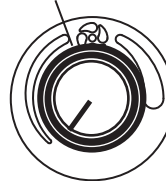

Mode Control



Temperature Control

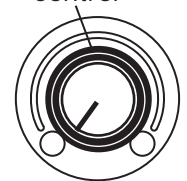

## A/C Operation

### Blower Speed

Adjust to desired speed.

### Mode Control

Adjust to desired mode position (DASH position recommended).

### Temperature Control

For A/C operation, adjust to coldest position to engage compressor (Adjust between HOT and COLD to reach desired temperature).



## Heat Operation

### Blower Speed

Adjust to desired speed.

### Mode Control

Adjust to desired mode position (FLOOR position recommended).

### Temperature Control

For maximum heating, adjust to hottest position (Adjust between HOT and COLD to reach desired temperature).

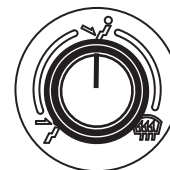

## Defrost/De-fog Operation

### Blower Speed

Adjust to desired speed.

### Temperature Control

Adjust to desired temperature.

### Mode Control

Adjust to DEFROST position for maximum defrost, or between FLOOR and DEFROST positions for a bi-level blend (Compressor is automatically engaged).

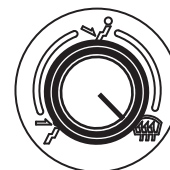



www.vintageair.com

# Troubleshooting Guide

Symptom	Condition	Checks	Actions	Notes
1a. Blower stays on high speed when ignition is on.	No other functions work.	Check for damaged pins or wires in control head plug.	Verify that all pins are inserted into plug. Ensure that no pins are bent or damaged in ECU.	Loss of ground on this wire renders control head inoperable.
	All other functions work.	Check for damaged ground wire (white) in control head harness. Check for damaged blower switch or potentiometer and associated wiring.	Verify continuity to chassis ground with white control head wire at various points.	See blower switch check procedure.
1b. Blower stays on high speed when ignition is on or off.		Unplug 3-wire BSC control connector from ECU. If blower shuts off, ECU is either improperly wired or damaged.	Be sure the small, 20 GA white ground wire is connected to the battery ground post. If it is, replace the ECU. Check to ensure that no BSC wiring is damaged or shorted to vehicle ground. The BSC operates the blower by ground side pulse width modulation switching. The positive wire to the blower will always be hot. If the "ground" side of the blower is shorted to chassis ground, the blower will run on HI.	
		Unplug 3-wire BSC control connector from ECU. If blower stays running, BSC is either improperly wired or damaged.	Replace BSC (This will require removal of evaporator from vehicle).	No other part replacements should be necessary.
2. Compressor will not turn on (All other functions work).	System is not charged.	System must be charged for compressor to engage.	Charge system or bypass pressure switch.	<b>Danger: Never bypass safety switch with engine running. Serious injury can result.</b> To check for proper pot function, check voltage at white/blue wire. Voltage should be between 0V and 5V, and will vary with pot lever position.
	System is charged.	Check for faulty A/C potentiometer or associated wiring (Not applicable to 3-pot controls). Check for disconnected or faulty thermistor.	Check continuity to ground on white control head wire. Check for 5V on red control head wire. Check 2-pin connector at ECU housing.	Disconnected or faulty thermistor will cause compressor to be disabled.
3. Compressor will not turn off (All other functions work).		Check for faulty A/C potentiometer or associated wiring.	Repair or replace pot/control wiring.	Red wire at A/C pot should have approximately 5V with ignition on. White wire will have continuity to chassis ground. White/Blue wire should vary between 0V and 5V when lever is moved up or down.
		Check for faulty A/C relay.	Replace relay.	





www.vintageair.com

# Troubleshooting Guide (Cont.)

Symptom	Condition	Checks	Actions	Notes
4.	Works when engine is not running; shuts off when engine is started (Typically early Gen IV, but possible on all versions).	Noise interference from either ignition or alternator.	Install capacitors on ignition coil and alternator. Ensure good ground at all points. Relocate coil and associated wiring away from ECU and ECU wiring. Check for burned or loose plug wires.	Ignition noise (radiated or conducted) will cause the system to shut down due to high voltage spikes. If this is suspected, check with a quality oscilloscope. Spikes greater than 16V will shut down the ECU. Install a radio capacitor at the positive post of the ignition coil (See radio capacitor installation bulletin). A faulty alternator or worn out battery can also result in this condition.
	System will not turn on, or runs intermittently.	Verify connections on power lead, ignition lead, and both white ground wires.	Check for positive power at heater valve green wire and blower red wire. Check for ground on control head white wire.	
	Will not turn on under any conditions.	Verify battery voltage is greater than 10 volts and less than 16.	Verify proper meter function by checking the condition of a known good battery.	
5.	Loss of mode door function.	Check for damaged mode switch or potentiometer and associated wiring.		Typically caused by evaporator housing installed in a bind in the vehicle. Be sure all mounting locations line up and don't have to be forced into position.
		Check for obstructed or binding mode doors.		
		Check for damaged stepper motor or wiring.		
6.	Blower turns on and off rapidly.	Battery voltage is at least 12V at circuit breaker.	Ensure all system grounds and power connections are clean and tight.	System shuts off blower at 10V. Poor connections or weak battery can cause shutdown at up to 11V.
		Battery voltage is less than 12V.	Charge battery.	
7.	Erratic functions of blower, mode, temp, etc.	Check for faulty battery or alternator.		
		Check for damaged switch or pot and associated wiring.	Repair or replace.	
8.	When ignition is turned on, blower momentarily comes on, then shuts off. This occurs with the blower switch in the OFF position.	This is an indicator that the system has been reset. Be sure the red power wire is on the battery post, and not on a switched source. Also, if the system is pulled below 7V for even a split second, the system will reset.	Run red power wire directly to battery.	



www.vintageair.com

# Packing List: Evaporator Kit (751200)

No.	Qty.	Part No.	Description
1.	1	744016	Gen IV Evaporator Sub Case
2.	1	791200	Accessory Kit

Checked By: \_\_\_\_\_  
 Packed By: \_\_\_\_\_  
 Date: \_\_\_\_\_

1

Gen IV Evaporator  
Sub Case  
744016

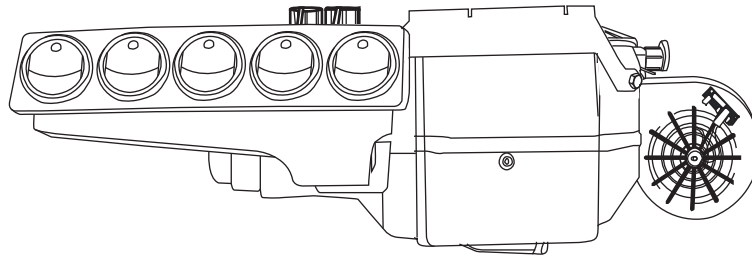

2

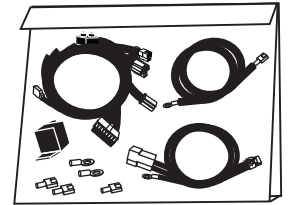
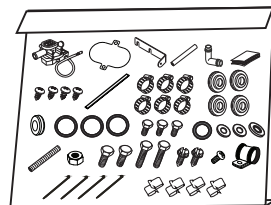
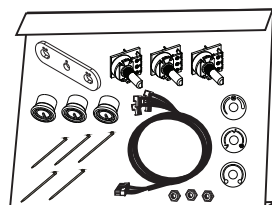
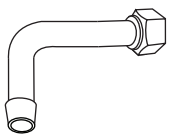
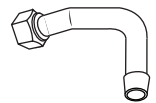
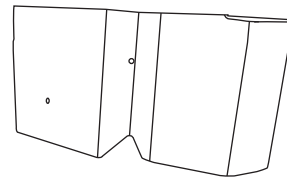
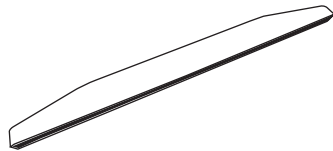
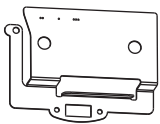
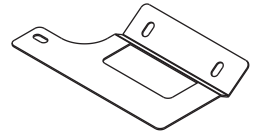
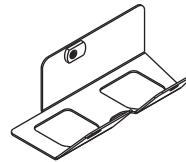
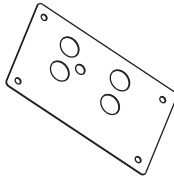
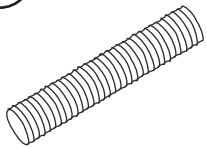

Accessory Kit  
791200

**NOTE: Images may not depict actual parts and quantities.  
 Refer to packing list for actual parts and quantities.**